

# TRANS



## LRS-509 series

Line Voltage Occupancy Sensor

### INSTALLATION INSTRUCTIONS

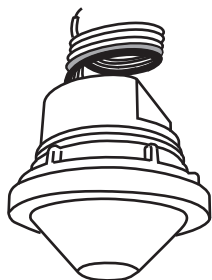

w/Lens A/B/C

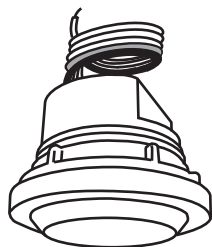

w/Lens D

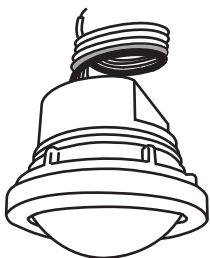

w/Lens F

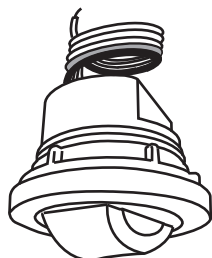

w/Lens G

\*More lens options are available for this sensor.  
Please refer to the Lens Datasheet for more details.

### OVERVIEW

The LRS-509 series member of the TRANS family is a 2-way IR remote programmable line voltage switching occupancy sensor designed for all-purposes energy efficient lighting control.

This state-of-the-art occupancy sensor employs a cutting edge quad-element pyroelectric infrared sensor to provide omni-directional sensing capability of occupant's presence and movements. The sensor can be easily programmed with specific delay time and ambient light level as desired, or download the existing settings of installed sensor from the floor via a two-way handheld IR remote programmer. An exclusive Hybrid Switching technology allows the LRS-509 series to control a group of LED lightings that could generate exceptionally high inrush current (HIC) while switching on.

Like all sensors in the TRANS family, the LRS-509 series is also available with various mounting options and interchangeable lenses. This provides a second-to-none design and complete installation flexibility. The sensor is designed to operate in the coldest of environments, down to  $-40^{\circ}\text{C}/^{\circ}\text{F}$ . The LRS-509 is designed to provide complete occupancy sensing for automatic lighting control, ease of use, and the simplest installation possible.

### APPLICATION NOTES

1. The sensor is more sensitive to the movements "crossing" the detection zones than "toward" or "away" the sensor unit. To obtain better sensitivity, avoid placing the sensor in line with occupant path, if possible.
2. The closer the movement is to the sensor, the more sensitive the sensor is. The higher the sensor is installed, the larger movement is required to be detected.
3. Ensure to place the sensor at least at 1.5m (5 ft.) away from air supply ducts as rapid air flow may cause false activations.
4. The sensor cannot "see" the movements behind obstacles, such as furniture, shelf, glass or partition. As a general rule, each occupant should be able to clearly view the sensor unit.
5. For open office areas with partition which could block the sensor view to occupant movements, it is best to place the sensors over the intersection of multiple workstations. For large areas of open office or space, place multiple sensors so that there is overlap coverage with each adjacent sensor.

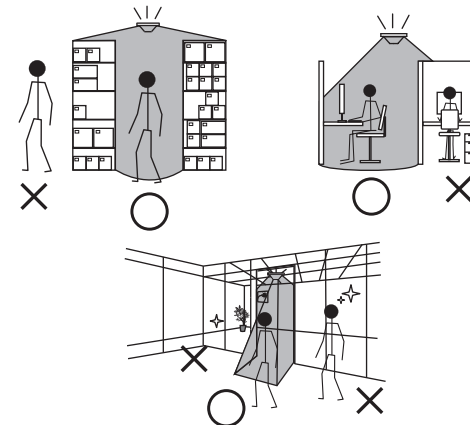

### WARNING & CAUTION

- Risk of Electric Shock - Disconnect power supply before servicing.
- Do NOT touch the square window of infrared sensor under the lens assembly.
- Open Type Photoelectric Switches.

### AVERTISSEMENT & PRUDENCE

- Risque de choc électrique - Débranchez l'alimentation avant l'entretien.
- Ne PAS toucher la fenêtre carrée de capteur infrarouge sous l'ensemble de l'objectif.
- Ouvrir Type commutateurs optoélectroniques.



www.irtec.com

P/N: 058-50913-002

Printed in Taiwan

This product may be covered by one or more U.S. patents or patent applications.  
Please visit [www.irtec.com](http://www.irtec.com) for more information.



## CONTROL MODE

The LRS-509 sensor can be programmed by SRP-280 remote programmer to control the lighting in one of the following modes. For more details of specific control mode, please visit [www.irtec.com](http://www.irtec.com) or contact an IR-TEC team member directly.

Mode	Control (LRD-509Sxx)
<b>ON/OFF</b>	<ol style="list-style-type: none"> <li>While ambient lux is <b>higher</b> than the level set, light stays <b>OFF</b>.</li> <li>While ambient lux is <b>lower</b> than the level set, and <b>occupancy detected</b>, switch the light to <b>ON</b>.</li> <li>Turn <b>OFF</b> the light after occupant leave and delay time elapses.</li> </ol>
<b>OFF</b>	This is a manual control mode can be used when you need the light to be off for a certain period of time. Once this mode is set, all lighting controlled by the sensor/controller will remain off until another mode is selected.

## SENSOR ACKNOWLEDGMENT

Acknowledgement	Sensor LED	Beep	Lighting
Full sensor setting upload completed	-	Long x 1 Short x 2	Flash x 2
Sensor resume to factory default	-	-	Flash x 2
Single setting ok	-	Short x 2	-
Occupancy detected	Flash x 1	-	-

## SENSOR SETTINGS

The followings are settings and options available with LRS-509 that can be configured through the operation of SRP-280 remote programmer. For more details of remote sensor setting, please refer to the operation instruction of SRP-280.

Settings	Description	Options (*Denotes factory default.)
<b>CONTROL</b>	The mode that the sensor will control.	<b>ON/OFF*</b> , OFF
<b>AMBIENT LUX</b>	The ambient light level that sensor will perform the control.	10/20/40/60/100/200/400 LUX/ <b>DISABLED*</b>
<b>DELAY</b>	The delay time that sensor is set to turn off or dim the light after the area is vacant.	30 sec./1/3/5/ <b>10*</b> /15/20/30/60 min.
<b>SENSITIVITY</b>	The sensitivity of occupancy sensor.	<b>HIGH*</b> /NORMAL/LOW

## WIRING DIAGRAM

### A. Single sensor control

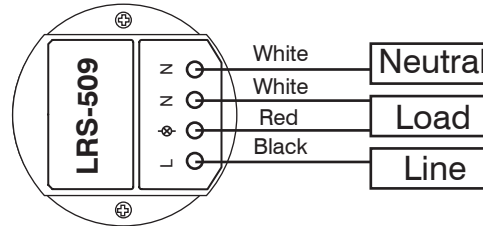

### B. Multiple sensors control

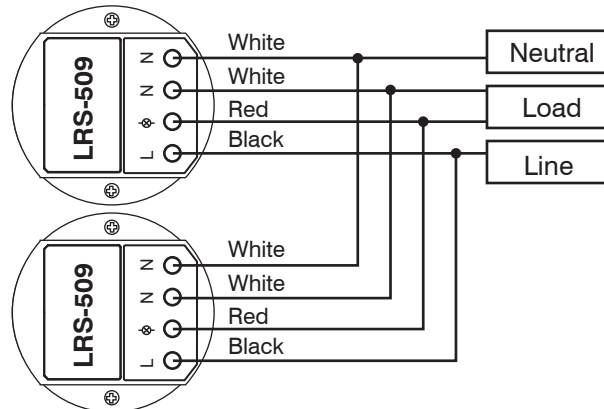

## SPECIFICATIONS

Power supply	100/120/230/277VAC, 50/60 Hz		
Maximum Load	100-120VAC	230VAC	277VAC
	-Incandescent/Halogen	800/*500W(VA)	5A 1200/*750W(VA)
	-Fluorescent Ballast/CFL	800/*500W(VA)	5A 1200/*750W(VA)
	-Ballast Electronic (LED)	540/*500VA	5A 1200/*750VA
Infrared sensor	Omni-directional quad element pyroelectric		
HIC protection	Max. 80A for 16.7msec.		
Detectable speed	0.3~3 m/sec (1~10 ft./sec.)		
Mounting height	Subject to the lens type applied.		
Detection range	Subject to the lens applied and height		
Remote range	> 10m (33 ft.) indoor, no backlight		
Op. humidity	Max. 95% RH		
Op. temperature	-40°C~70°C (-40°F~158°F)		
Dimensions	Ø60 x H37mm (Ø2.36"x H1.45")		

\*Max load for operating temperature at 55°C~70°C (131°F~158°F)

## WARRANTY

IR-TEC International Ltd. warrants this product to be free of defects in materials or workmanship for a period of five years from date of shipment. There are no obligations or liabilities on the part of IR-TEC International Ltd. for consequential damages arising out or in connection with the use or performance of this product or other indirect damages with respect to loss of property, revenue, or profit, or cost of removal, installation or reinstallation.