

TRANS

BPD-510 series

Low Voltage Daylight Sensor

INSTALLATION INSTRUCTIONS

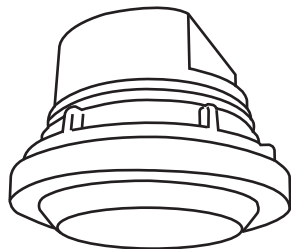

INDOOR USE ONLY

Utilisation à l'interieur Uniquement

⚠ WARNING & CAUTION

- Turn power OFF at circuit breaker before installing Power Pack or Sensors.
- Do Not Install To and/or Cover a Junction Box Having Class 1, 3 or Power and Lighting Circuits
- Class 2 Device Wiring Only – Do Not Reclassify and Install as Class 1, 3 or Power and Lighting Wiring
- Suitable wiring range 16-20 AWG solid copper wire only

⚠ AVERTISSEMENT & PRUDENCE

- Coupez l'alimentation au disjoncteur avant d'installer Power Pack ou capteurs.
- Ne pas installer ou couvrir une boîte de jonction ayant les classes 1 et 3 ou circuits de puissance et d'éclairage.
- Classe 2 Câblage de périphériques Seulement - Ne PAS reclasser et installer Classe 1, 3 ou alimentation et circuits d'éclairage
- Convient gamme de câblage 16-20 AWG en cuivre massif seulement.

OVERVIEW

The BPD-510 series member of the TRANS family is a low voltage daylight sensor designed to provide digital and analog output for automatic daylight controls through the connected Power Pack or panel system.

This closed loop daylight sensor employs a cutting edge digital ambient light sensor (ALS) with an advanced algorithm to constantly measure the ambient light level in the controlled area. When the ambient light level is lower/higher than the set value for a period of time, the sensor will automatically engage/disengage its isolated dry contact output to turn the connected light ON/OFF.

In addition to the digital output, the sensor also provides 5 different 0-10V analog output ranges pre-settable via Accu-Set potentiometer to report the local ambient light level in timely basis for BMS control.

INSTALLATION NOTES

1. Care must be taken when selecting the mounting location of sensor. The ambient light level may vary greatly at different measure points in the room, depending on the location of the windows, lighting fixtures, wall colors, floor material, desk top, etc.
2. It is recommended to mount the sensor directly above the work space, such as desk or conference table.
3. Note the path of shadows which may affect the sensor operation. Daylighting control may be problematic if part of controlled area is in shadows while other part has plentiful daylight.
4. The sensor is designed to measure ambient light level by looking down from ceiling height. Sensing performance will vary if sensor is mounted to look out from wall. Avoid installing the sensor to directly look into the skylight, the daylight level will exceed the maximum threshold of sensor.
5. The ambient light level on the ceiling can be much lower than that at the windows, corners of the room, or especially the workplace level. Therefore, it is important to measure the light level over the workplace.

SELECTING A LOCATION

The BPD-510 series daylight sensor can be applied to control lights in areas that receive sufficient daylight, thus the electric lights can be reduced or switched OFF. It is important to select a location for the BPD-510 series where the representative daylight of the controlled area is available.

Side-lighting area

If the primary daylight source is a window, the daylight sensor is typically mounted between the window and the first row of fixtures.

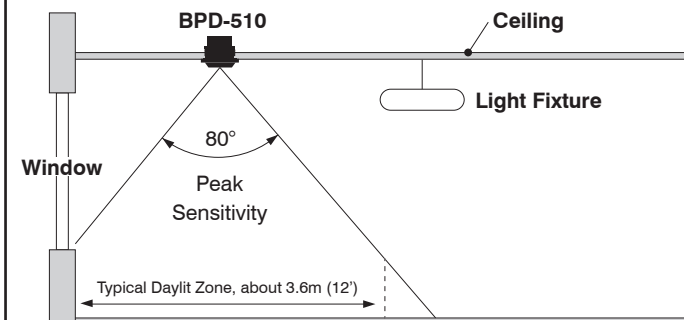

Top-lighting area

If the primary daylight source is a skylight, the daylight sensor should be mounted on the ceiling between the skylight and fixtures, looking down at the floor.

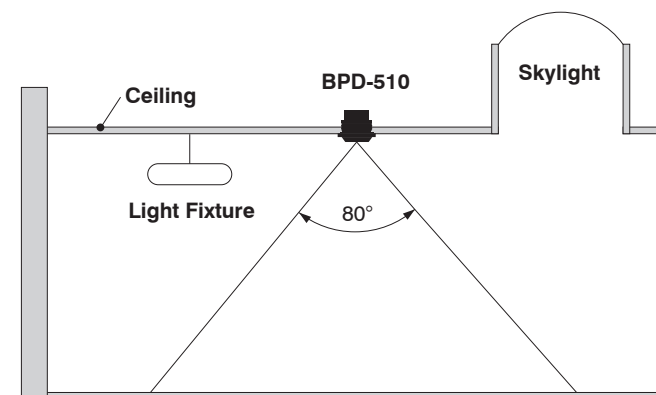

WIRING DIAGRAM

Following diagrams are provided for wiring reference. Consult with a professional BMS engineer or an IR-TEC team member if a more complex wiring diagram is required.

A. Building Management System control

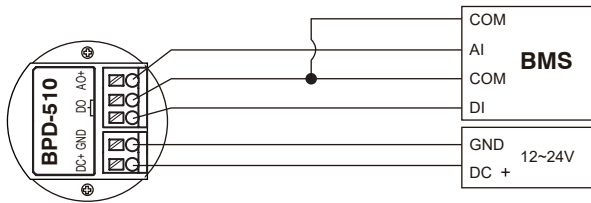

B. Power Pack control

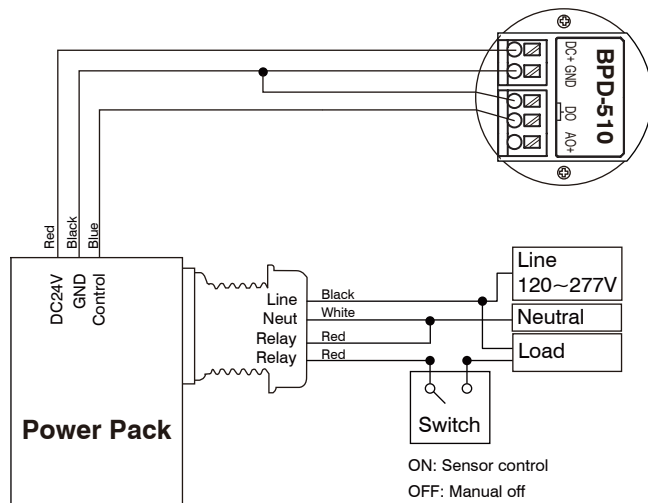

INSTALLATION

The BPD-510 series can be mounted onto the ceiling surface, recess mounted into the ceiling, installed in a 4" junction box, integrated or externally attached to a fixture via various mounting brackets. For more details of available mounting options, please refer to the separate instructions attached.

OPERATION

After the sensor installed and correct wiring completed, apply power to the sensor for operation. The LED will blink once every 2 seconds for 5 minutes after the power applied. The sensor will start measuring the ambient light level of controlled area and the LED will blink once every 15 seconds to indicate sensor operation. The relay contact will be engaged if the ambient light level is lower than the nighttime threshold set for more than 15 seconds. An automatic dead-band calibration will be activated to compensate the light level increase contributed by electrical lighting, thus avoid switching OFF the lights unnecessarily.

The sensor also provides 0-10V output which responds the ambient light level of controlled area. This analog output can be applied for more sophisticated lighting control via relay panel or BMS.

SENSOR SETTINGS

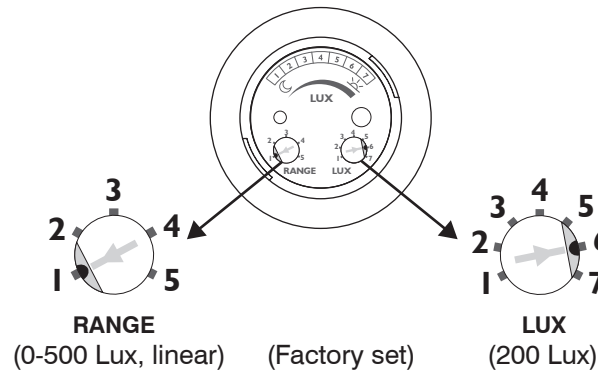

POS.	1	2	3	4	5	6	7
LUX	10	20	40	60	80	200	400
RANGE	0-500 linear	0-2,500 linear	0-20,000 linear	0-2,000 linear	0-2,000 non-linear	N/A	N/A

*10 lux equals to approximately 1 ft. candle

Factory Set

LUX - Ambient Light Level

The BPD-510 series features 7 different ambient light level thresholds selectable via Accu-Set digital potentiometer. The sensor will inhibit its output if ambient light is higher than set level.

RANGE - Output vs Ambient Light Level

5 different sensing ranges are available for setting via Accu-Set digital potentiometer. Following charts indicate respective output vs ambient light level ranges at different setting positions of potentiometer marked RANGE.

The lux level ranges are typical data obtained from lab test. Actual performance may vary with different installation site. On-site calibration may be required if precise control is desired.

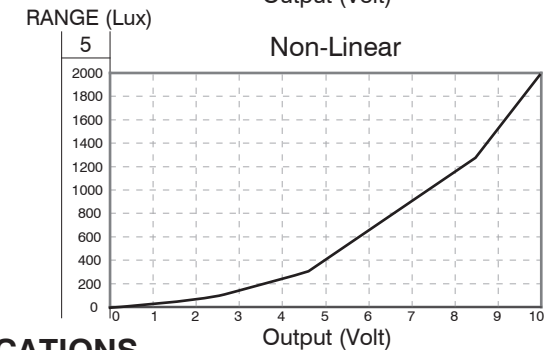
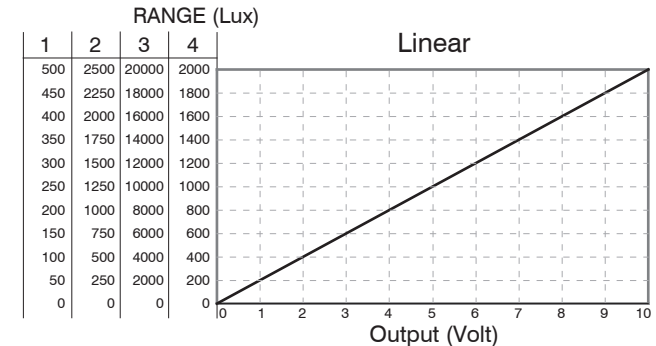

SPECIFICATIONS

Power supply	12~24 VDC \pm 5%
Photo sensor	Digital data control ambient light sensor
Current drain	15mA typical
Digital output (DO)	Isolated dry contact, max. 1A
Analog output (AO)	0-10V
Sensing range	5 range Accu-Set digital potentiometer
Mounting height	2.4~3.6m (8~12 ft.)
Field of view	Approx. 80°
ON/OFF threshold	7-level Accu-Set digital potentiometer
Op. humidity	Max. 95% RH
Op. temperature	-40°C~55°C (-40°F~131°F)
Dimensions	Ø65 x H45mm (Ø2.56"x H1.77")