

WALLSENZR

LBS-700 Series

Line Voltage Wall Switch Sensor

INSTALLATION INSTRUCTIONS

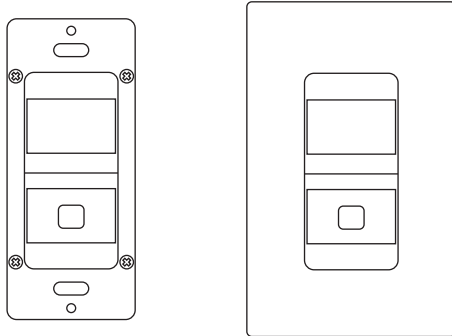

Indoor dry location use only
Utilisation a L'interieur Uniquement

⚠ WARNING & CAUTION

- Risk of Electric Shock - Disconnect power supply before servicing.
- DO NOT control a load in excess of specified ratings to avoid damaging the sensor or the property.
- Install and use this sensor in accordance with electrical codes and regulations.
- This device is intended to be installed by a qualified electrician. DO NOT attempt to service or repair.

⚠ AVERTISSEMENT & PRUDENCE

- Risque de choc électrique - Débranchez l'alimentation avant l'entretien.
- NE PAS contrôler une charge supérieure à la capacité spécifiée pour éviter d'endommager le capteur ou la propriété.
- Installer et utiliser ce capteur conformément aux codes et règlements électriques.
- Ce dispositif est destiné à être installé par un électricien qualifié. NE PAS tenter de réparer.

OVERVIEW

The LBS-700 is a member of IR-TEC's WALLSENZR family of line voltage wall switch sensor designed to fit in a standard NEMA wall box with no neutral connection required. The sensors combine state-of-the-art passive infrared sensing technology with décor aesthetics to provide optimal energy-saving for all applications.

The sensor will turn ON the load automatically when it detects the presence of an occupant, and will turn OFF automatically if no motion is detected before the delay time elapses. To meet compliance of specific energy code, such as CA Title 24, the LBS-700 series can be easily programmed as a Vacancy sensor. In Vacancy mode the sensor will only turn ON the load by pressing the push-button manually and will turn OFF the load automatically per the sensor time delay. The LBS-700 allows for the push-button operation to be programmed with different manual control options.

The model LBS-700S comes with an ambient light sensor (ALS) to inhibit the lighting if ambient light levels are higher than required. The Accu-Set potentiometers make delay time (TIME) and ambient light level (LUX) settings fast, easy and accurate. Hybrid-Switching control allows the LBS-700 series to control the lighting with high inrush current (HIC) while switching ON, such as multiple LED or CFL lightings connected in parallel.

DETECTION COVERAGE

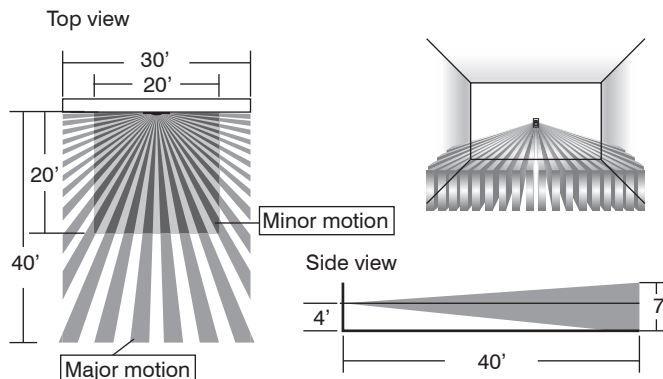

INSTALLATION NOTES

1. The sensor is more sensitive to the movements "crossing" the detection zones than "toward" or "away" the sensor. To obtain better sensitivity, ensure the sensor to have clear field of view for the occupant's motion within the desired coverage.
2. The closer movement is to the sensor, the more sensitive the sensor is.
3. The sensor should be mounted within the specified mounting height for optimal performance.
4. Avoid blocking the sensor with any obstacles, such as door, plant, partition or furniture. As a general rule, every occupant within the desired range should be able to clearly see the sensor.
5. Do NOT mount the sensor directly above or nearby a heat source, or where unintended motion (e.g. hallway traffic) will be "seen" by the sensor.

SPECIFICATIONS

Power supply	120/277VAC, 60Hz
Maximum load	Incandescent/Halogen – 800W (VA)
	Fluorescent Ballast/CFL – 800W (VA)
	Ballast Electronic (LED) – 500/800VA@120/277V
	Motor – 1/6 HP
Infrared sensor	Dual element pyroelectric
Switching control	Zero-cross Hybrid-Switching
Inrush current	Max. 80A, 20 mS
Detectable speed	1~10 ft./sec. (0.3~3 m/sec)
Mounting height	3 ~ 5 ft. (90~150 cm) above the floor
Detection coverage	Major motion - 30 ft x 40 ft (W x L) @4 ft high
	Minor motion - 20 ft x 20 ft (W x L) @4 ft high
Ambient light level	7 levels, from dark to 24 Hr., LBS-700S only
Delay time setting	T/1'/3'/5'/10'/20'/30' , T=10 sec. for testing
Op. humidity	Max. 95% RH, non-condensate
Op. temperature	-40°F ~ 131°F (-40°C ~ 55°C)
Dimensions	4.13"H x 1.77"W x 1.65"D (w/mounting plate)



www.irtec.com P/N: 058-70000-006

Printed in Taiwan

This product may be covered by one or more U.S. patents or patent applications. Please visit www.irtec.com for more information.



WIRING DIAGRAM

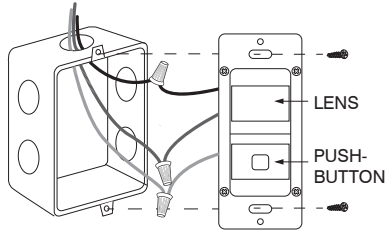

NOTE:
The **GREEN** wire **MUST** be connected to the **GROUND** for operation

• Single-Pole Control

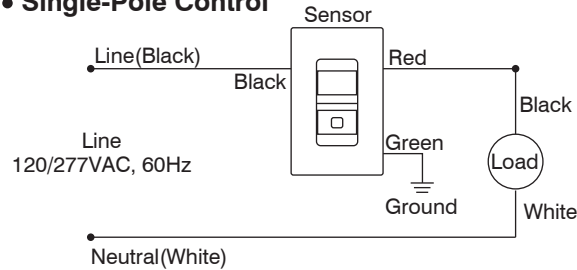

• 3-Way Control

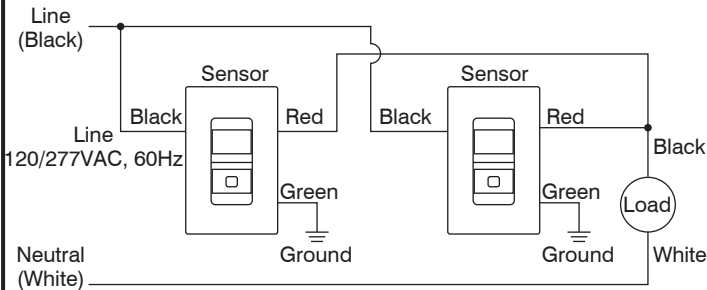

The sensor may be available with other control options, consult a qualified electrician or contact info@irtec.com for assistance.

INSTALLATION

1. Ensure the power has been turned OFF at the circuit breaker.
2. Prepare the wires with proper length (cut the excessive length, if necessary) and strip for connection. Connect the sensor wires to the wires of line voltage and load according to the above wiring diagram of desired control.
3. Carefully bend the wires in the wall box after all wires are properly connected. Mount the sensor in the wall box with the screws provided.
4. Conduct sensor operation test (refer to the TESTING section). Replace the wall plate cover after sensor testing and setting completed.

OPERATION

The LBS-700 series wall switch sensor employs passive infrared (PIR) sensing technology to monitor the occupancy status within its coverage, and control the connected load as per sensor setting. The sensor can be programmed to control the load as an Occupancy Sensor or Vacancy Sensor via setting DIP switch #1. The push-button operation can be programmed to turn the load ON and OFF manually or in Presentation Mode (PM) for specific requirement via setting DIP switch #2.

To change the sensor operation mode or settings, press the push-button cover and slide it down as shown.

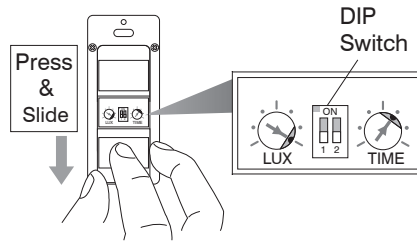

Sensor Mode

Occupancy Sensor
(Auto-ON, Auto-OFF)

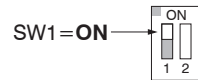

Occupancy sensor switches the light ON automatically when it detects the presence of an occupant. The sensor will switch the light OFF automatically if no occupant activity has been detected before the time delay elapses.

Vacancy Sensor
(Manual-ON, Auto-OFF)

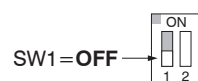

Vacancy sensor requires the user to manually press the push-button to turn ON the light. The sensor will switch the light OFF automatically if no occupant activity has been detected before the time delay elapses.

NOTE - The sensor will automatically turn ON the light if it detects occupant activity within 30 seconds after time delay elapsed.

Push-button Control

Manual ON/OFF

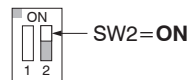

Pressing the push-button during occupied state will turn OFF the load immediately and hold off until the push-button is pressed again.

Presentation Mode

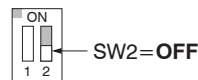

In Presentation Mode (PM), pressing the push-button will turn OFF the lights immediately, and the lights will remain off even if motion is detected. Pressing the push-button again will turn the light ON and the sensor will operate per its settings. If the time delay expires and no occupant activity has been detected, the sensor will return to its normal operation. The lights will turn on with the next motion detected.

SETTING

The LBS-700S features ambient light sensor to inhibit unnecessary lighting when ambient light is higher than the level set. The time delay (TIME) and ambient light level (LUX) settings can be changed by rotating the respective Accu-Set potentiometer at different positions.

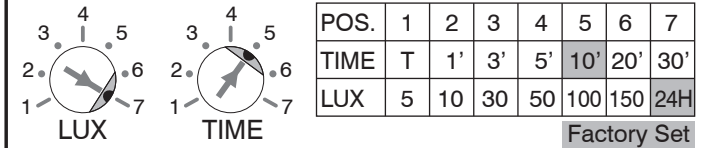

TIME - Delay time

This is the delay time that the LBS-700 series sensor will hold the load on after the last motion detected. The factory setting is 10 minutes, and it can be changed by pointing the arrowhead of potentiometer to the specific position.

LUX - Ambient light level (LBS-700S only)

This is the threshold of ambient light level that the LBS-700S sensor will inhibit switching on the load. The factory setting is ALS disabled (24 Hr) for ease of testing, and it can be changed by pointing the arrowhead of potentiometer to the specific position.

TESTING

1. Restore line voltage power for the sensor at circuit breaker (power up time is approx. 1-5 min).
2. An LED behind the sensor lens will blink to indicate the motion sensed.
3. Replace the wall plate cover after completing sensor testing and setting.

NOTE: The connected load will be switched on as delay time set (factory default 10 minutes) once apply the power. The delay time can be set to the shortest (10 seconds) for ease of testing. **Ensure to set the TIME as desired for optimum operation after testing.**

WARRANTY

IR-TEC International Ltd. warranties this product to be free of defects in materials or workmanship for a period of five years from date of shipment. There are no obligations or liabilities on the part of IR-TEC International Ltd. for consequential damages arising out or in connection with the use or performance of this product or other indirect damages with respect to loss of property, revenue, or profit, or cost of removal, installation or reinstallation.