

WALLSENZR

LBT-700 Series

Line Voltage Wall Switch Sensor

INSTALLATION INSTRUCTIONS

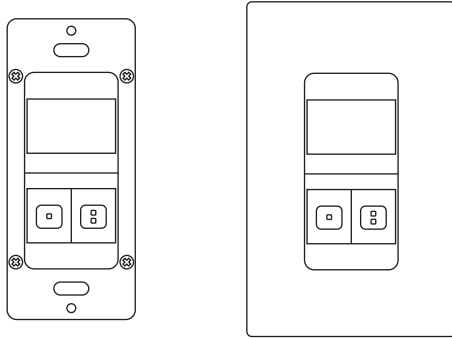

Indoor dry location use only
Utilisation a L'interieur Uniquement

⚠ WARNING & CAUTION

- Risk of Electric Shock - Disconnect power supply before servicing.
- DO NOT control a load in excess of specified ratings to avoid damaging the sensor or the property.
- Install and use this sensor in accordance with electrical codes and regulations.
- This device is intended to be installed by a qualified electrician. DO NOT attempt to service or repair.

⚠ AVERTISSEMENT & PRUDENCE

- Risque de choc électrique - Débranchez l'alimentation avant l'entretien.
- NE PAS contrôler une charge supérieure à la capacité spécifiée pour éviter d'endommager le capteur ou la propriété.
- Installer et utiliser ce capteur conformément aux codes et règlements électriques.
- Ce dispositif est destiné à être installé par un électricien qualifié. NE PAS tenter de réparer.

OVERVIEW

The LBT-700 is a member of IR-TEC's WALLSENZR family of 2-pole line voltage wall switch sensor designed to fit in a standard NEMA wall box with no neutral connection required. The sensors combine state-of-the-art passive infrared sensing technology with décor aesthetics to provide optimal energy-saving for all applications.

The LBT-700 contains two relays, and two push buttons, for controlling two lighting loads or circuits independently. To comply with specific energy code, such as CA Title 24, the sensor is factory set to control the primary load (pole 1) in occupancy sensing mode, and the secondary load (pole 2) in vacancy sensing mode. A variety of control options can be programmed via DIP switch settings to meet specific energy code or customer requirements.

The model LBT-700S comes with an ambient light sensor (ALS) to inhibit the lighting if ambient light levels are higher than required. The Accu-Set digital potentiometers make delay time (TIME) and ambient light level (LUX) settings fast, easy and accurate. Patent pending Hybrid-Switching control allows the LBT-700 series to switch on two separate loads with high inrush current (HIC) such as multiple LED or CFL lights connected in parallel.

DETECTION COVERAGE

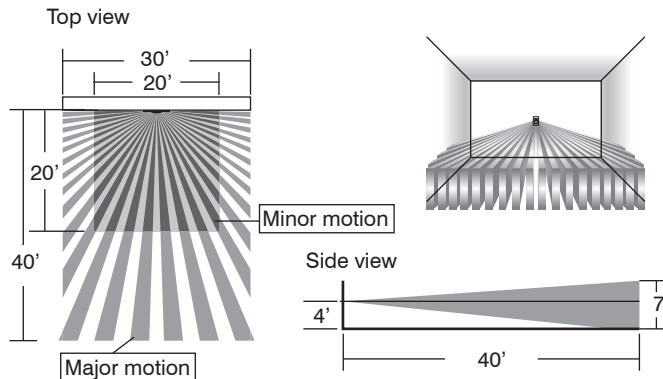

INSTALLATION NOTES

1. The sensor is more sensitive to the movements "crossing" the detection zones than "toward" or "away" the sensor. To obtain better sensitivity, ensure the sensor to have clear field of view for the occupant's motion within the desired coverage.
2. The closer movement is to the sensor, the more sensitive the sensor is.
3. The sensor should be mounted within the specified mounting height for optimal performance.
4. Avoid blocking the sensor with any obstacles, such as door, plant, partition or furniture. As a general rule, every occupant within the desired range should be able to clearly see the sensor.
5. Do NOT mount the sensor directly above or nearby a heat source, or where unintended motion (e.g. hallway traffic) will be "seen" by the sensor.

SPECIFICATIONS

Power supply	120/277VAC, 60Hz
Maximum load, per pole	Incandescent/Halogen – 800W (VA)
	Fluorescent Ballast/CFL – 800W (VA)
	Ballast Electronic (LED) – 500/800VA@120/277V
	Motor – 1/6 HP
Infrared sensor	Dual element pyroelectric
Inrush current	Max. 80A, 20 mS, per pole
Switching control	Zero-crossing with Hybrid-Switching
Detectable speed	1~10 ft./sec. (0.3~3 m/sec)
Mounting height	3 ~ 5 ft. (90~150 cm) above the floor
Detection coverage	Major motion - 30 ft x 40 ft (W x L) @4 ft H
	Minor motion- 20 ft x 20 ft (W x L) @4 ft H
Ambient light level	7 levels, from dark to 24Hr, LBT-700S only
Delay time setting	T/1'/3'/5'/10'/20'/30', T=10 sec. for testing
Op. humidity	Max. 95% RH
Op. temperature	-40°F ~ 131°F (-40°C ~ 55°C)
Dimensions	4.13"H x 1.77"W x 1.65"D (w/mounting plate)



www.irtec.com P/N: 058-70001-006 Printed in Taiwan
This product may be covered by one or more U.S. patents or patent applications.
Please visit www.irtec.com for more information.



WIRING DIAGRAM

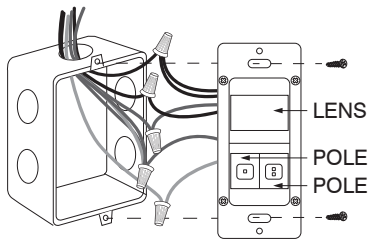

NOTE:
The **GREEN** wire **MUST** be connected to the **GROUND** for operation

• Bi-Level Control

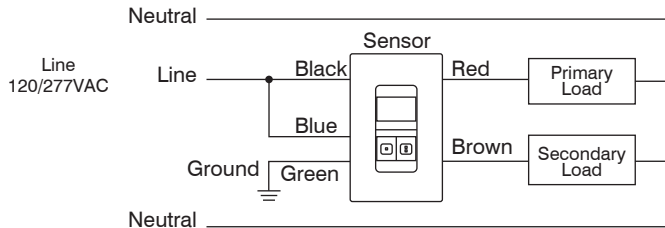

• Dual Circuit Control

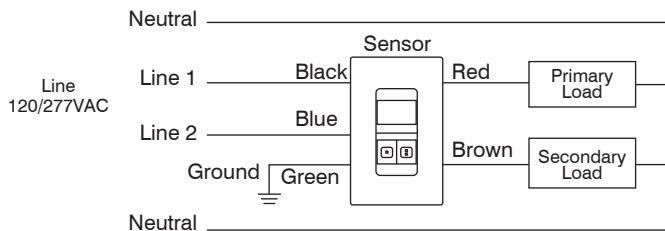

The sensor may be available with other control options, consult a qualified electrician or contact info@irtec.com for assistance.

INSTALLATION

1. Ensure the power has been turned OFF at the circuit breaker.
2. Prepare the wires with proper length (cut the excessive length, if necessary) and strip for connection. Connect the sensor wires to the wires of line voltage and load according to the above wiring diagram of desired control.
3. Carefully bend the wires in the wall box after all wires are properly connected. Mount the sensor in the wall box with the screws provided.
4. Conduct sensor operation test (refer to the TESTING section). Replace the wall plate cover after sensor testing and setting completed.

OPERATION

The LBT-700 series wall switch sensor employs passive infrared (PIR) sensing technology to monitor the occupancy status through an exclusive lens with 180° field of view. The sensor provides typical occupancy sensing (Auto-ON, Auto-OFF) control on pole 1 and vacancy sensing (Manual-ON, Auto-OFF) control on pole 2. Different control options of each pole can be achieved through DIP switch settings.

Control Mode

Occupancy Sensing Only Control (OSOC)

The sensor will turn the load ON automatically whenever it detects the presence of occupant, and switch the load OFF automatically if no occupant motion has been detected before the time delay elapses.

Applicable		DIP SW Setting
Model	pole	
LBT-700N	1	

SW1 = ON
SW2 = ON/OFF

Occupancy Sensing Only with PM (OSOP)

The sensor operates as in OSOC, but with Presentation Mode (PM) via push-button operation for specific requirement.

LBT-700N	1	
----------	---	--

SW1 = OFF
SW2 = ON/OFF

Occupancy Sensing with ALS (OSAC)

The sensor operates as in OSOC, but with the ALS to inhibit switching on the light when ambient light level is higher than the set threshold.

LBT-700S	1	
----------	---	--

SW1 = ON
SW2 = ON/OFF

Occupancy Sensing with ALS & PM (OSAP)

The sensor operates as in OSAC, but with the ALS and Presentation Mode (PM) both active.

LBT-700S	1	
----------	---	--

SW1 = OFF
SW2 = ON/OFF

Vacancy Sensing Only Control (VSOC)

This requires occupant to press the pole 2 push-button to turn ON the load, and the sensor will switch OFF the load automatically if no occupant motion has been detected before the time delay elapses. The sensor will automatically turn ON the load if it detects occupant activity within 30 seconds after time delay elapsed.

LBT-700N	2	
----------	---	--

SW1 = ON/OFF
SW2 = ON

LBT-700S	2	
----------	---	--

SW1 = ON/OFF
SW2 = ON

Pole One with Extended Delay (POED)

The sensor will control the load of pole 2 as per pole 1 set with Extended Delay (ED) for 5 minutes.

LBT-700N	2	
----------	---	--

SW1 = ON/OFF
SW2 = OFF

LBT-700S	2	
----------	---	--

SW1 = OFF
SW2 = OFF

Ambient Light Sensing Only (ALSO)

The sensor will automatically turn ON the connected load pole 2 when ambient light is lower than the LUX level set, and turn OFF the load when ambient light is higher than the threshold.

LBT-700S	2	
----------	---	--

SW1 = ON
SW2 = OFF

Presentation Mode (PM) allows the occupant to switch off the load as desired by pressing the specific push-button. The load will remain off if motion is detected before the time delay elapses. Pressing the push-button again will turn the load back ON and the sensor will operate as per sensor setting. If no motion has been detected and the time delay expires, sensor will return to normal operation and turn on the load with the next sensed motion.

To program the sensor operation mode or change the settings, press the push-button cover and slide it down as shown.

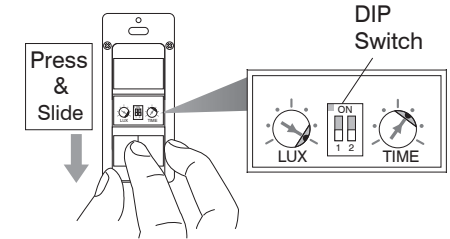

SETTING

The LBT-700 series provides 7 different delay time and ambient light level (LBT-700S only) settings via rotating the Accu-Set potentiometer at respective position as table below.

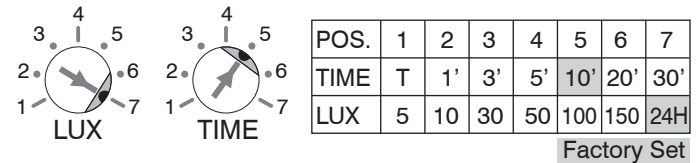

TIME - Delay time

This is the delay time that the LBT-700 series sensor will hold the load on after the last motion detected. The factory setting is 10 minutes, and it can be changed by pointing the arrowhead of potentiometer to the specific position.

LUX - Ambient light level (LBT-700S only)

This is the threshold of ambient light level that the sensor will inhibit switching on the load. The factory setting is ALS disabled (24 Hr) for ease of testing, and it can be changed by pointing the arrowhead to the specific position.

TESTING

1. Restore line voltage power for the sensor at circuit breaker (power up time is approx. 1-5 min).
2. An LED behind the sensor lens will blink to indicate the motion sensed.
3. Replace the wall plate cover after completing sensor testing and setting.

NOTE: The connected load will be switched on as delay time set (factory default 10 minutes) once apply the power. The delay time can be set to 10 seconds (T) for testing convenience. **Ensure to set the TIME back to desired delay for optimum operation after testing.**