



INFINITY

Hi-Tech Passive Infrared Detector

Installation Instructions



INFINITY



Hi-Tech Passive Infrared Detector IR-150 / 150AM / 150QA

FEATURES

The INFINITY is a Hi-Tech passive infrared detector designed for professional installation of commercial, industrial security systems.

- Anti-masking & spraying protection *
- Microprocessor signal processing
- Unique Motion Signal Discretion (MSD) circuit
- Dynamic automatic self test diagnosis
- First-to-alarm and second-to-alarm
- Positive / negative control voltage input
- N.C / N.O alarm output selectable
- Selectable trouble output format
- Remote control walk test LED indication
- Advanced temperature compensation
- 3D fresnel lens white light protection
- Multiple look down detection
- Supreme RFI & EMI protection
- Programmable intelligent pulse count

* Only available on IR-150AM, IR-150QA

DETECTION PATTERN

110°, 15 x 15m at 25°C

Top View

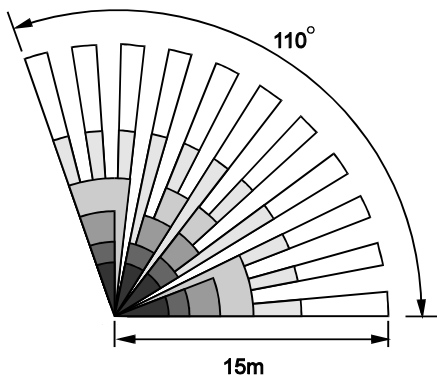

Side View

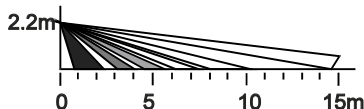

INSTALLATION HINTS

The INFINITY may be either wall or corner mounted by applying different knockouts. The MB-95 mounting bracket can be applied for ceiling mount. Corner mount is generally recommended for optimum detection. Select a rigid surface that is free of vibration and note the following;

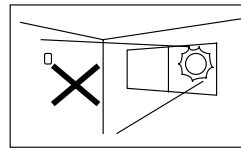

Do not install where the detector is in or facing direct / reflected sunlight, windows onto main roads (car head lights).

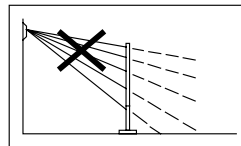

Ensure that there are not any obstructions (plants, screens, furniture etc.) in the field of view which may cause incorrect cover/operation of the detector.

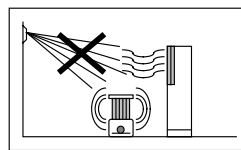

Avoid locating the detector in areas which contain equipment that may change the environment temperature rapidly.

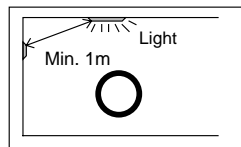

Locate the detector at least 1 meter away from any illumination to avoid possible interference to anti-masking function.

Avoid running alarm wiring close to mains cables !!!

INSTALLATION & WIRING

Installation

1. Open the front cover by loosening the locking bolt at the bottom of the case.
2. Remove the printed circuit board from the base of the unit, by bending the P.C.B clips gently upwards (handle printed circuit board with care).
3. Punch out the required knockouts and mount the unit base to the wall, corner or bracket.
4. Lead the cable through the access hole and then refit the printed circuit board.
5. Connect the wires to the respective terminals according to the wiring instructions.
6. Replace the front cover* after completing the wiring and carry out a thorough walk test.

* Before replacing cover, carefully locate the TX LED into position and close the cover, by a gentle upward movement locate the locking lugs and then tighten the bottom bolt. (Anti-masking only)

Wiring

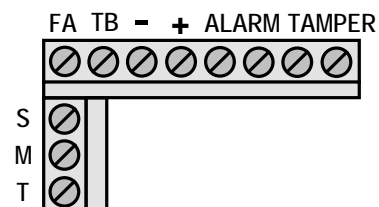

- FA** : First-to-alarm (Parallel connection)
- TB** : Trouble signal (Normal:12 V, Trouble: 0 V)
- +** : Power input (9 ~ 16 VDC)
- ALARM** : Alarm output (N.C / N.O selectable)
- TAMPER** : Tamper & trouble output
- S** : Spare (For end-of-line resistor)
- M** : Alarm memory (Control voltage)
- T** : Alarm LED remote control (+12 VDC)

Wiring of alarm memory and first-to-alarm

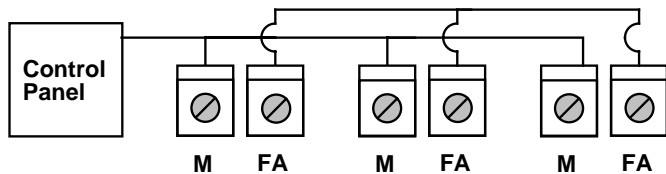

A compatible alarm control panel is required for alarm memory and first-to-alarm function. Alarm memory will reset when system is re-armed.

DESCRIPTION

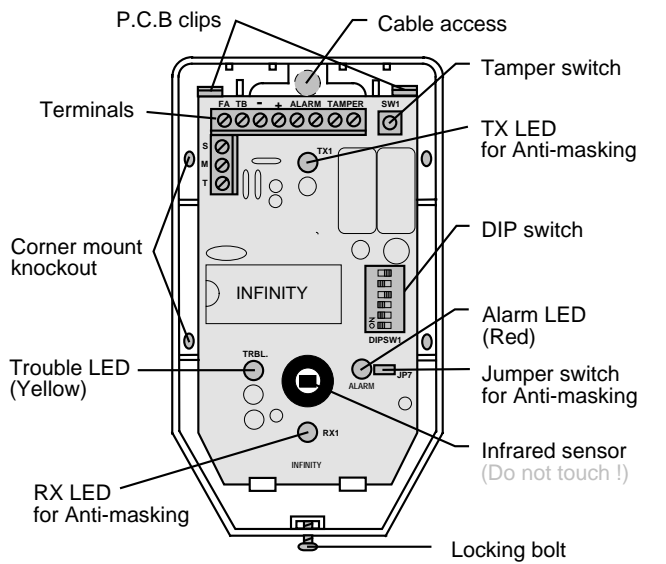

!

DIP SWITCH SETTING

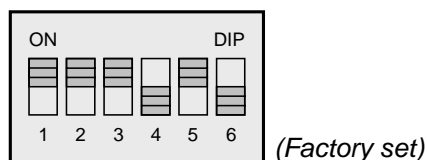

PIN 1 - Alarm memory control voltage

Pin 1	ON	OFF
Voltage	Positive	Negative
Armed	+5 ~ 16VDC	0 ~ 0.5VDC
Disarm	0 ~ 0.5VDC	+5 ~ 16VDC

When using the alarm memory feature. The detector that is triggered first will have the alarm LED (red) flashing, any other detectors triggered will have the alarm LED (red) in a latched condition. The alarm memory will automatically reset when the

system is rearmed.

PIN 2 - Alarm output mode

Pin 2	ON	OFF
Mode	N.C	N.O

PIN 3 - Alarm LED (Red) remote control

Pin 3	ON	OFF
LED	ON	OFF

If alarm LED remote control is on, the alarm LED will lit when motion is detected while system disarmed.

PIN 4 & 5 - Pulse count selection

Pulse Count	1	2	3	4
Pin 4	OFF	OFF	ON	ON
Pin 5	OFF	ON	OFF	ON

PIN 6 - Trouble output mode

Pin 6	ON	OFF
Mode	Trouble	Tamper + Trouble

Trouble signal will be generated when detector is masked, sprayed or failed at automatic self-test.

LED Indication

LED	Flickering	Latch
Red	First-to-alarm unit	Second & follow
Yellow	Detector masked	Detector failed

First-to-alarm function helps to identify the detector which was triggered first when several detectors are connected parallel in one loop.

ANTI-MASKING & SPRAYING

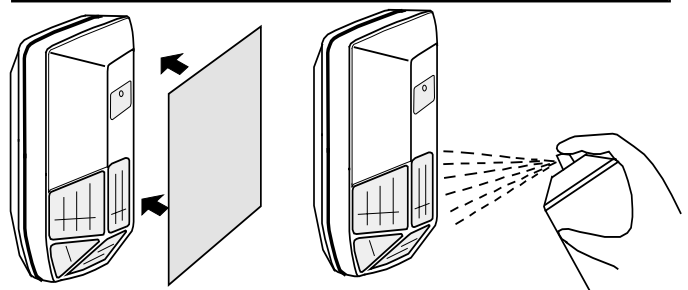

The anti-masking & spraying system detects the unit being masked or sprayed (approximately 30cm for 10 sec.). The trouble LED will flash to indicate this condition. Trouble output format can be selected by the repositioning of the DIP switch PIN 6. The anti-masking function is activated by the removal of jumper loop JP7. (Only available on IR-150AM & IR-150QA)

SELF TEST DIAGNOSIS

The INFINITY has automatic self test diagnosis (using a microprocessor) once every 6 hours to ensure the detector's normal operation. If the detector is faulty or in abnormal status, a trouble signal (12V → 0V) will be sent through the terminal marked "TB" to the control panel. The trouble LED (yellow) will latch to indicate this condition.

MOTION SIGNAL DISCRETION

The MSD (Motion Signal Discretion) circuit recognizes the difference between motion and non-motion signals. Alarm output is only generated when motion is detected by infrared sensor and analyzed by the MSD circuit. MSD circuit ensures supreme reliability even when environmental conditions are severe.

WALK TEST

It is necessary to carry out a thorough walk test of the detector to ensure that the correct coverage is being achieved after installation. When first powered up the detector will take approximately 50 seconds to warm up. After this warm up time, confirm detection coverage by walking across the detection zones at normal speed. The alarm LED will light for approximately 2 seconds whenever motion is detected.

When you have completed the walk test, the alarm LED can be switched to off from DIP switch. If the alarm LED can be remotely activated for further walk testing by applying positive 12 VDC to the terminal marked "T". This is a very convenient and time saving feature as it enables all detectors in the installation to be regularly walk tested without having to manually switch each and every detector.

 *Regular walk testing must be carried out, as part of your routine maintenance visits at least once a year.)*

SPECIFICATIONS

Power supply	9 ~ 16 VDC
Detection range	15 x 15m at 25°C
Control voltage.....	Pos. / neg. trigger selectable
Current drain.....	28 / 18mA (N.C./ N.O)
Anti-masking	About 30 cm for 10 seconds
Alarm period	2 ± 0.5 sec.
Alarm output	N.C / N.O, 30 VDC, 0.2A max.
Trouble signal	Normal: 12V, trouble: 0V
Alarm LED	Red, can be disabled
Trouble LED.....	Yellow
Tamper switch	N.C. cover open activates
Pulse count.....	1 / 2 / 3 / 4 selectable
RFI immunity.....	Ave. 30V/m (10~1000 MHz)
Mounting height	2.0 ~ 2.6m
Ceiling bracket	MB-95 (Optional)
Detectable speed.....	0.3 ~ 1.5m/sec.
Detection zones	68 zones
Humidity	95% RH max.
Temperature	-10°C ~ 55°C (14°F ~ 131°F)
Dimensions	125 x 68 x 42mm
Unit weight	110 grams

In order to continue improving its product, IR-TEC reserves the right to change specifications without prior notice.

MAINTENANCE & TROUBLE SHOOTING

PROBLEM	PROBLEM CAUSE	REMEDY
Alarm (red) LED does not light	Alarm LED switch is OFF.	Turn on the PIN 3 of DIP switch.
	Incorrect polarity of power supply.	Change pos. and neg. at terminal blocks.
	Wrong control voltage from panel.	Check control voltage of DIP switch setting.
	Incorrect power supply voltage.	Correct voltage supply to 9 ~ 16 VDC.
	Alarm memory not apply.	Turn off the PIN 1 of DIP switch.
Alarm (red) LED continue to light	Second-to-alarm or following alarm memory.	It will reset automatically when system is re-armed.
Trouble (yellow) LED lights	Circuit does not operate properly during by self test diagnosis.	Replace with a new unit. (See self test diagnosis section)
Trouble (yellow) LED flickers	Something masks or shields detector's view.	Remove the masking or shielding. (See anti-masking & spraying section.)
	Sunlight or other strong light direct / reflected the detector.	Change the detector location.