

SOLO

Energy Saving Auto-Switch

LC-730 / 730D

GENERAL

SOLO series Energy Saving Auto-Switch is an innovative automatic light switch designed to mount with single switch gang box. By using IR-TEC's patented 2-wire DuCAS technology, SOLO is able to activate almost all kinds of light without the need of neutral wire. Just install SOLO like a manual wall switch, it will switch on the light automatically whenever someone enters its detection range. The light will go off automatically if the area is unoccupied.

DETECTION PATTERN

Top View

140°, 10 x 10m (at 25°C)

Side View

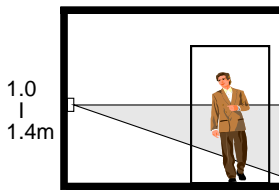
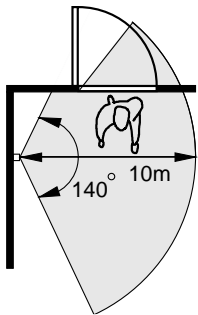

INSTALLATION

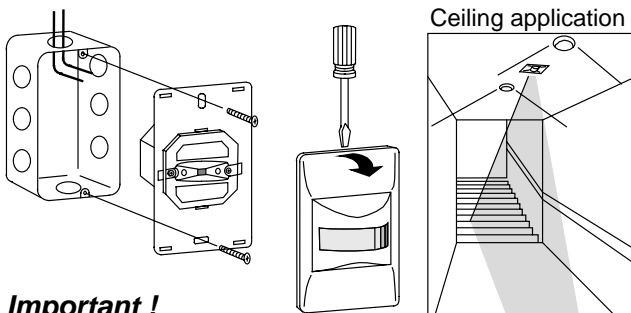

Important !

1. Do not install SOLO behind the opened door, curtain or any objects may block the sensor.
2. Do not replace the front cover up side down. Note the "UP" mark inside the front cover.
3. SOLO may not be available with some electronic PL lamps.
4. Use blade-type screwdriver to remove the front cover as shown.



Installation Instructions

WIRING DIAGRAM

A: For single control

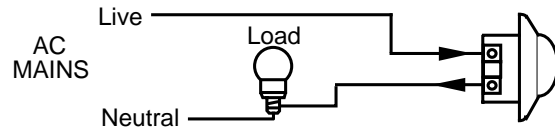

B: For heavy load or non-applicable PL lamp.

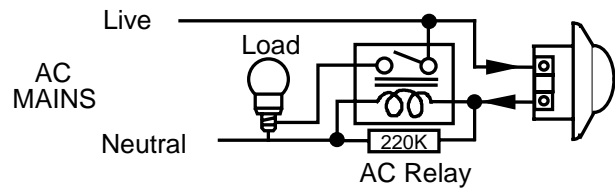

FUNCTION DESCRIPTION

Model	Operation description
LC-730	All-time operation (No lux control). Fixed delay time (typical 1 min.).
LC-730D*	Same as LC-730. 20% automatic dimmer at dusk.

* LC-730D is only available with incandescent lamp.

SPECIFICATIONS

Detection method	Passive Infrared (PIR)
Infrared sensor	Dual element, low noise
Power supply	100~230 VAC, 50 / 60 Hz
Detection range	140°, 10m at 25°C
Delay time	Approx. 1 min.
Load capacity	3A @110V, 1.5A @230V
Screw pitch	83.50 mm
Mounting height	1.0 ~ 1.4m (3.3 ~ 4.6 ft)
Temperature	-20° ~ 50°C (-4° ~ 122°F)
Dimensions	120 x 70 x 50 mm
Unit weight	128 gram



SOLO

Energy Saving Auto-Switch

LC-730S / 730T

DETECTION PATTERN

Top View

140°, 10 x 10m (at 25°C)

Side View

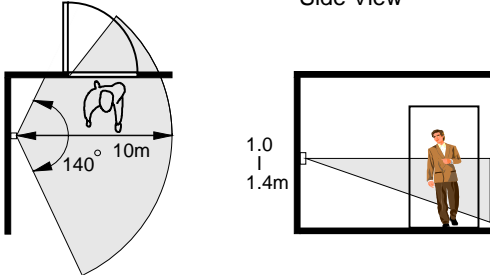

WIRING DIAGRAM

A. LC-730S single control

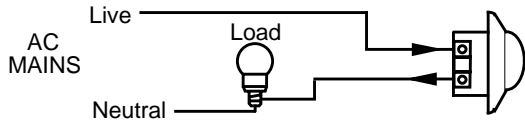

B. For heavy load or non-applicable PL lamp

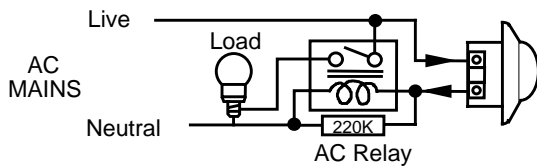

C. LC-730T Two-way parallel control

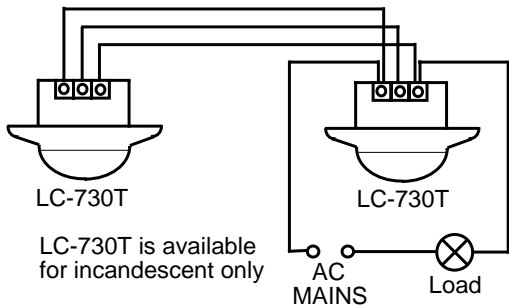

LC-730T is available for incandescent only

INSTALLATION

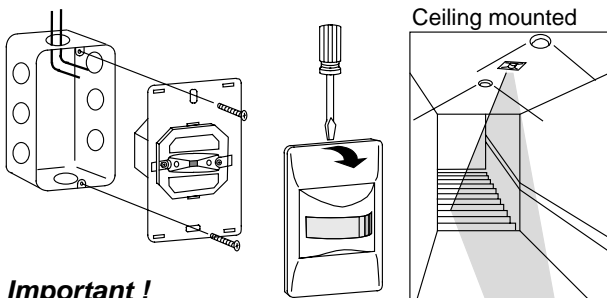

Important !

- Do not install SOLO behind the opened door, curtain or any objects may block the sensor.
- Do not place the front cover up side down. Note the "UP" mark inside the front cover.



Installation Instructions

TEST & ADJUSTMENTS

- Apply AC power and the light will be switched on about 30 seconds for SOLO to warm up.
- Walk across within the detection range, light will be switched on whenever motion is detected.
- Adjust the **TIME** and **LUX** controllers to set the desired light-on threshold and delay time.

TIME

Light-on delay time can be set from approximate 8 seconds to 6 minutes. Further detection during delay time will reset the timer.

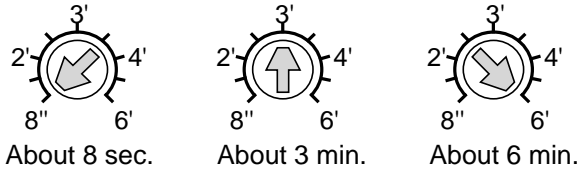

LUX

A built-in CdS photocell determines the operation of by sensing the ambient light level.

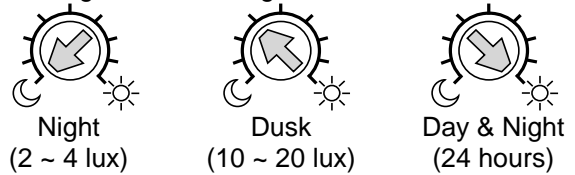

SPECIFICATIONS

Detection method	Passive Infrared (PIR)
Infrared sensor	Dual element, low noise
Power supply	120 VAC, 60 Hz
Detection range	140°, 10m at 25°C
Delay time	8 sec. ~ 6 min.
Load capacity	Max. 120V, 300W (Resistive)
Screw pitch	83.50mm
Mounting height	1.0 ~ 1.4m (3.3 ~ 4.6 ft)
Temperature	-20° ~ +50°C (-4° ~ +122°F)
Dimensions	120 x 70 x 50 mm
Unit weight	130 gram

