

# TRANS

## LOS-502 series

Line Voltage Occupancy Sensor

### INSTALLATION INSTRUCTIONS

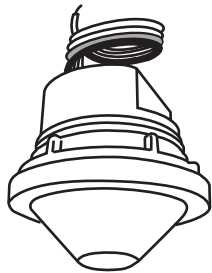

w/Lens A/B/C

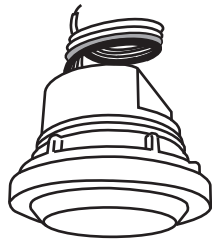

w/Lens D

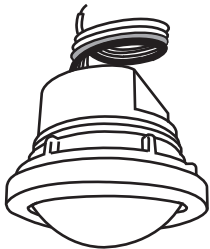

w/Lens F

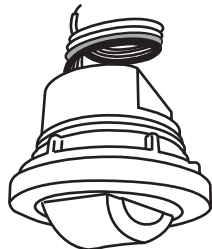

w/Lens G

\*More lens options are available for this sensor.  
Please refer to the Lens Datasheet for more details.

### OVERVIEW

The LOS-502 series member of the TRANS family is a line voltage switching occupancy sensor designed for all-purposes energy efficient lighting control.

This occupancy sensor employs a cutting edge quad element pyroelectric infrared sensor to provide omni-directional sensing capability of occupant's presence and movements. The Accu-Set digital potentiometer makes the sensor setting easier, faster and more accurate than the conventional analog potentiometer.

Like all sensors in the TRANS family, the LOS-502 series is available with various mounting options and interchangeable lenses. This provides a second-to-none design and complete installation flexibility. The sensor is designed to operate in the coldest of environments, down to  $-40^{\circ}\text{C}/^{\circ}\text{F}$ .

The LOS-502 series comes with an ambient light sensor (ALS) to inhibit the lighting if ambient light levels are higher than required. The LOS-502 is designed to provide complete occupancy sensing for automatic lighting control, ease of use, and the simplest installation possible.

### INSTALLATION NOTES

1. The sensor is more sensitive to the movements "crossing" the detection zones than "toward" or "away" the sensor unit. To obtain better sensitivity, avoid placing the sensor in line with occupant path, if possible.
2. The closer the movement is to the sensor, the more sensitive the sensor is. The higher the sensor is installed, the larger movement is required to be detected.
3. Ensure to place the sensor at least at 1.5m (5 ft.) away from air supply ducts as rapid air flow may cause false activations.
4. The sensor cannot "see" the movements behind obstacles, such as furniture, shelf, glass or partition. As a general rule, each occupant should be able to clearly view the sensor unit.
5. For open office areas with partition which could block the sensor view to occupant movements, it is best to place the sensors over the intersection of multiple workstations. For large areas of open office or space, place multiple sensors so that there is overlap coverage with each adjacent sensor.

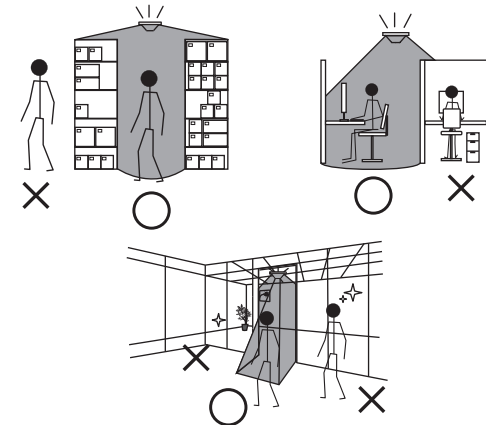

### ⚠ WARNING & CAUTION

- Risk of Electric Shock - Disconnect power supply before servicing.
- Do NOT touch the square window of infrared sensor under the lens assembly.
- Open Type Photoelectric Switches.
- Cycling the power to the sensors will cause failure over time.

### ⚠ AVERTISSEMENT & PRUDENCE

- Risque de choc électrique - Débranchez l'alimentation avant l'entretien.
- Ne PAS toucher la fenêtre carrée de capteur infrarouge sous l'ensemble de l'objectif.
- Ouvrir Type commutateurs optoélectroniques.



www.irtec.com P/N: 058-50201-003 Printed in Taiwan  
This product may be covered by one or more U.S. patents or patent applications.  
Please visit [www.irtec.com](http://www.irtec.com) for more information.



## WIRING DIAGRAM

### A. Single sensor control

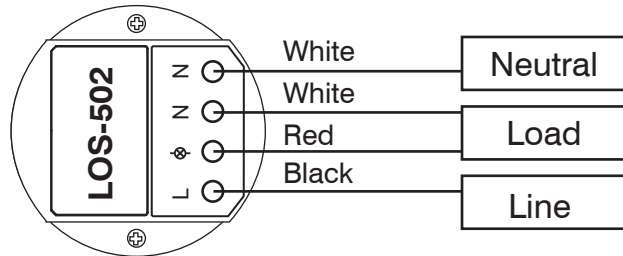

### B. Multiple sensors control

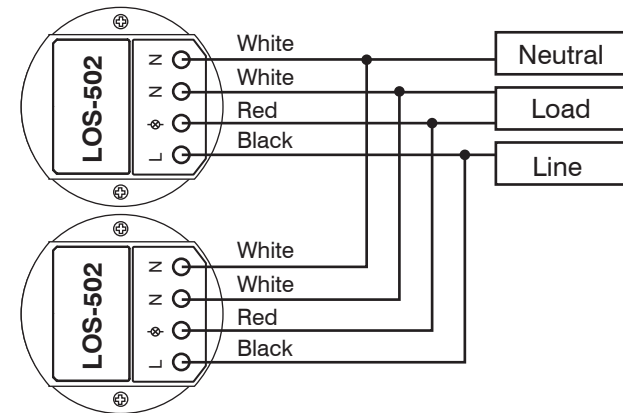

## TESTING

### Sensor Range Test

1. Ensure the shaft of LUX is set at "7" position.
2. Walk within the desired range\* at normal speed. Light should be switched ON as delay time set whenever sensor detects the presence or movement of occupant. To speed up test, you may set the shaft of TIME to "1" position (TEST) for shortest delay (10 seconds) for 10 minutes.
3. The LED indicator behind the lens assembly will blink to indicate sensor detection as well.

NOTE: Ensure to set TIME at the desired position for optimum delay after test. The delay time will resume to factory default (10 minutes) if the shaft has not been set to other position after 10 minutes.

\* Depending on the lens type ordered and mounting height, the sensor could have different sensing coverage as instructed on the LENS DATASHEET attached.

## SENSOR SETTINGS

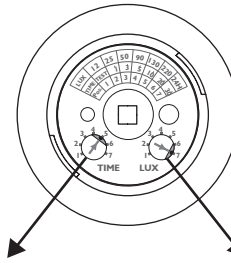

TIME

(10 minutes)

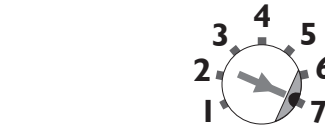

LUX

(Factory set) (ALS disabled)

SW. POS.	1	2	3	4	5	6	7
TIME	T*	1'	3'	5'	10'	20'	30'
LUX	12	25	50	90	130	220	24H

Factory Set

\*T=10 seconds shorten delay for testing convenience.

The sensor will automatically resume to the factory default delay setting after 10 minutes, if the potentiometer has not been adjusted to other position.

### TIME - Delay Time

This sensor offers 7 different delay time selection via Accu-Set potentiometers. The light will remain ON if sensor detects occupant's movement before the set delay time expires. Point the arrowhead on the TIME potentiometer to the desired time.

### LUX - Ambient Light Level

This sensor offers 7 different ambient light level selection via Accu-Set potentiometers. The sensor will not switch ON the light if the LUX value of ambient light is higher than set level. Point the arrowhead on the LUX potentiometer to the desired level.

## SPECIFICATIONS

Power supply	100/120/240/277VAC, 50/60Hz
Maximum load @ -40°C~55°C (-40°F~131°F-)	Fluorescent Ballast/CFL - 800/1200W(VA)@120/277V
	Ballast Electronic (LED) - 540/1200VA@120/277V
Maximum load @ 55°C~70°C (131°F~158°F)	Fluorescent Ballast/CFL - 500/750W(VA)@120/277V
	Ballast Electronic (LED) - 500/750VA@120/277V
Infrared sensor	Omni-directional quad element
Detectable speed	0.3~3m/sec. (1~10 ft./sec.)
Mounting height	Subject to the lens type applied
Detection range	Subject to the lens applied and height
Ambient light level	7 levels Accu-Set digital potentiometer
Delay time setting	T/1'/3'/5'/10'/20'/30', T=10 sec. for testing
Op. humidity	Max. 95% RH
Op. temperature	-40°C~70°C (-40°F~158°F)
Dimensions	Ø60 x H37mm (Ø2.36"x H1.45")

## WARRANTY

IR-TEC International Ltd. warrants this product to be free of defects in materials or workmanship for a period of five years from date of shipment. There are no obligations or liabilities on the part of IR-TEC International Ltd. for consequential damages arising out or in connection with the use or performance of this product or other indirect damages with respect to loss of property, revenue, or profit, or cost of removal, installation or reinstallation.