

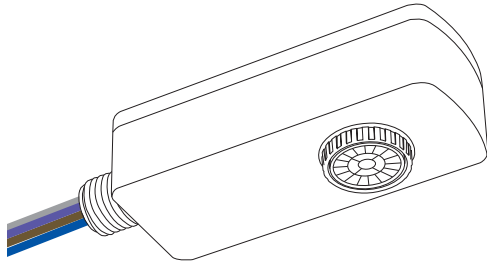

## ON-MRD-200SP **EU**

SmartDALI OS-NET Sensor

### INSTALLATION INSTRUCTIONS



### SPECIFICATIONS

Power supply	230-240 VAC or DALI bus power
Power consumption	<0.5W @277VAC or <60 mA with DALI bus
Infrared sensor	Omni-directional pyroelectric
Photo sensor	Digital ambient light sensor
DALI bus power	60 mA max.
Control protocol	DALI Broadcast
Wireless protocol	Modified Zigbee Light Link (ZLL)
Radio frequency	2,405~2,480 MHz
Radio channel	16
Radio range	5 m (16 ft) @ indoor only
Radio output power	7.58dBm
Detectable speed	0.15 ~ 3 m/sec. (0.5~10 ft./sec.)
Mounting height	2.4 ~ 6 m (8 ~ 20 ft)
Op. humidity	Max. 95% RH
Op. temperature	-40°C~70°C (-40°F~158°F)
Dimensions	140x48x40mm (5.51"x1.89"x1.50")

### WARNING & CAUTION

- Risk of Electric Shock - Disconnect power supply before servicing.
- Cycling the power to the sensors will cause failure over time.

### OVERVIEW

The ON-MRD-200SP is a low profile OS-NET Sensor (ONS) packed with multiple sensing control functionalities including occupancy/vacancy sensing, daylight harvesting, bi-level StepDIM or continuous SmartDIM, and wireless mesh networking capability for top-notch intelligent lighting control.

The sensor not only controls the connected lighting in the programmed mode independently when it detects the presence of an occupant/vehicle or change of ambient light level, but also acts as a network node to broadcast the OS-NET command for group lighting activation wirelessly. All network setup, grouping and control settings; including sensing control scheme, delay times, ambient light level threshold, ramp up/fade down speed, sensitivity, burn-in duration...etc. can be easily and intuitively configured via a 2-way handheld remote programmer (SRP-281) from the floor.

This IP-65 batten mount sensor can be externally assembled with an OEM luminaire through a 1/2" hole. A low profile flat lens provides excellent low-bay occupancy sensing capability within its coverage of 2X mounting height. With ON-MRD-200SP, you can effortlessly achieve code-compliant, energy efficient smart lighting control through a wireless sensor mesh network effortlessly deployed while installing the OS-NET enabled luminaires in commercial environments.

### DIMENSIONS

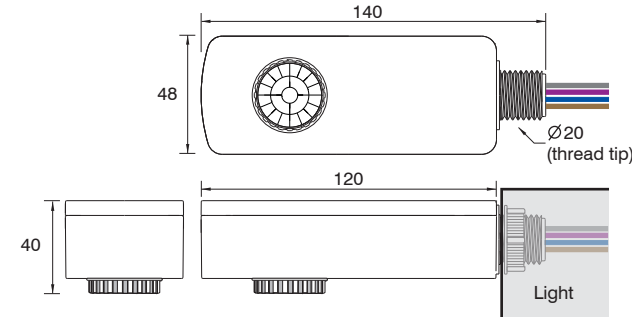

Unit: mm

### WIRING DIAGRAM

#### Powered by line voltage

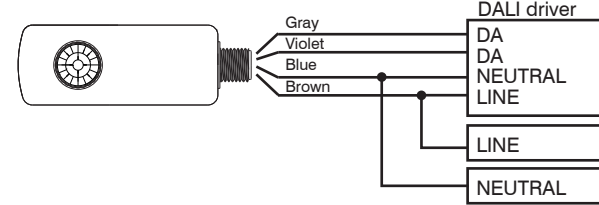

#### Powered by DALI bus

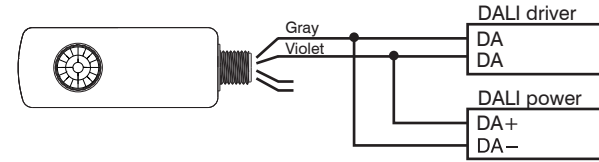

### APPLICATION NOTES

1. The sensor is more sensitive to the movements "crossing" the detection zones than "toward" or "away" the sensor unit. To obtain better sensitivity, avoid placing the sensor in line with occupant path.
2. The closer the movement is to the sensor, the more sensitive the sensor is. The higher the sensor is installed, the larger movement is required to be detected.
3. Ensure to place the sensor at least at 1.5m (5 ft.) away from air supply ducts as rapid air flow may cause false activations.
4. The sensor cannot "see" the movements behind obstacles, such as tall furniture, shelf, glass or partitions. Avoid placing the sensor where obstructions may block the sensor's line of sight.
5. The partition of workstation could block the sensor view to occupant movements, it is best to place the sensor over the intersection of workstation. For large open office, place multiple sensors so that there is overlap coverage with each adjacent sensor.
6. To obtain optimal wireless communication range, avoid enveloping the sensor with a metallic enclosure.

### DETECTION COVERAGE

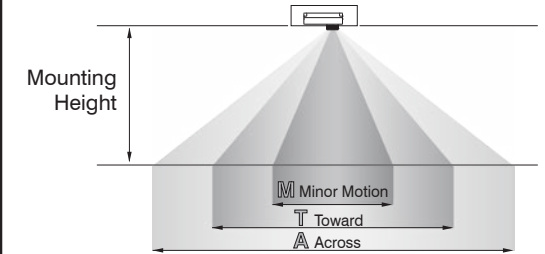

Mounting Height	2.4 m (8 ft)	3.0 m (10 ft)	3.6 m (12 ft)	6.0 m (20 ft)
Coverage Diameter	M	1.0 m (3 ft)	2.0 m (7 ft)	3.0 m (10 ft)
	T	3.0 m (10 ft)	4.0 m (13 ft)	5.0 m (16 ft)
	A	5.0 m (16 ft)	6.0 m (20 ft)	7.0 m (23 ft)

### MOUNTING

- ① Assemble the sensor with fixture via the knockout hole

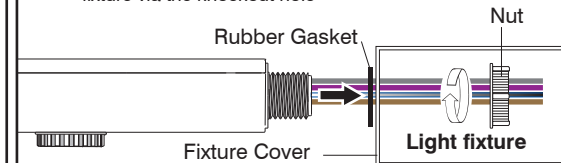

- ② Tighten the screw nut

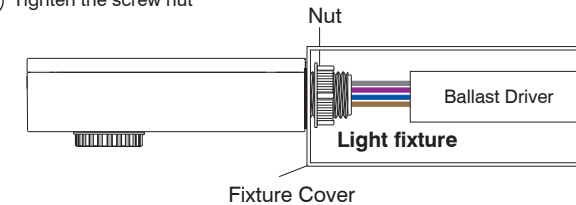

## SETTING

All sensor settings can be configured, in individual or group basis, by an OS-NET Remote Programmer SRP-281. Following table highlights the setting items and options available with ON-MRD-200SP. For detailed setting operation, please refer to the OS-NET Programming Guide available for download from [www.irtec.com](http://www.irtec.com).

Programming Guide



Settings	Description	Options	Default
<b>INDIV-SET</b>	To setup an individual device		
<b>GROUP-SET</b>	To setup all devices of the group with same settings		
<b>CONTROL</b>	Control schemes available for OS-NET sensor.	ON/OFF, OSO, OSLA, OSLATO, DSVM, DSC, VSC, OSB, OFF	OSLATO
<b>AMBIENT LUX</b>	Thresholds of ambient light level for OS-NET sensor to execute the control.	10/20/40/60/80/200/400/600/1000/2000 LUX DISABLED/CURRENT	DISABLED
<b>DELAY</b>	Delay time that sensor will turn off or fade down the light.	30 sec./1/3/5/10/15/20/30/60 min.	10 min.
<b>TIME OFF</b>	Delay time that sensor will keep the light at low dim level after the OFF delay time elapsed.	10/30 sec./3/5/10/15/20/30/45/60 min.	10 min.
<b>HIGH DIM</b>	High dim is the output level set to control the light during occupancy, or when ambient light is lower than the threshold if daylight sensing scheme is selected.	50/55/60/65/70/80/90/100%/SmartDIM	100%
<b>DALI Power</b>	Enable/disable the sensor to provide DALI bus power. NOTE: If total DALI bus power will exceed 250mA after adding the sensor powered by line voltage, please "DISABLE" the DALI POWER.	ENABLED/DISABLED	ENABLED
<b>LOW DIM/SmartDIM</b>	Low dim is the output level set to dim the light when space is vacant for bi-level control. Low dim setting will become SmartDIM bar if SmartDIM control is selected.	0/5/10/15/20/25/30/40%	30%
<b>RAMP UP</b>	Speed of lighting output increase.	INSTANT/SOFT/SLOW	INSTANT
<b>FADE DOWN</b>	Speed of lighting output decrease.	INSTANT/SOFT/SLOW	SOFT
<b>LED INDICATOR</b>	Enable or disable the LED indicator of the sensor.	ENABLED/DISABLED	ENABLED
<b>VM-TB</b>	Time duration BEFORE Virtual Midnight. Only available if DSVM is selected.	0.5/1/1.5/2/2.5/3/3.5/4/4.5/5/5.5/6 hour	2.5 hour
<b>VM-TA</b>	Time duration AFTER Virtual Midnight. Only available if DSVM is selected.	0.5/1/1.5/2/2.5/3/3.5/4/4.5/5/5.5/6 hour	4 hour
<b>SENSITIVITY</b>	Sensitivity of occupancy sensor. To disable the occupancy sensing capability, select OFF.	HIGH/NORMAL/LOW/OFF	HIGH

## SETTING ACKNOWLEDGEMENT

The sensor will acknowledge setting success or failure with different indications by device LED or connected lighting.

INDICATION	ACKNOWLEDGEMENT	REMARKS
Device LED fast blinking in GREEN and BLUE.	The device is scanning and linking to the network.	The fast blinking (on-off per 0.2 second) only appears during network linking.
Device LED blinks twice every 2-second in GREEN or BLUE.	The sensor detects occupant's motion.	GREEN means the device is network linked. BLUE means the device is unlinked.
Device LED blinks twice every 2-second for 5 minutes, and then 15-second after power applied.	The device is set with daylight sensing control. (DSVM or DSC)	GREEN means the device is network linked. BLUE means the device is unlinked.
Device short beeps twice.	Receiving a single setting or control command.	
Device beeps one long and two short. The connected lights flash twice.	1. Multiple setting data UPLOAD successful. 2. GROUP LINK successful.	
The connected lights flash twice.	1. Factory default setting resumed. 2. SmartDIM setting completed.	

## CONTROL SCHEME

The ON-MRD-200SP series can be programmed to control the connected lighting in one of the schemes as below.

Scheme	Description
<b>ON/OFF</b>	This is a typical <b>occupancy sensing control</b> scheme. Lighting will be inhibited when the ambient light level is higher than the set threshold, regardless of occupancy or vacancy. When the ambient light level is lower than the set threshold, the controlled light will be automatically turned on once the sensor detects the presence of occupant, and turned off after the delay time elapsed. <b>NOTE:</b> This scheme can be used with <b>dimmable</b> or <b>non-dimmable</b> lighting, but not for HID lighting.
<b>OSO</b>	This is an <b>occupancy sensing control</b> scheme can be applied in areas that require 24-hour lighting. When space is vacant, the lights will be maintained at Low Dim level. Whenever space is occupied, lighting output will be increased to High Dim level or continuously regulated to maintain within the pre-set range by SmartDIM control. <b>NOTE:</b> Do <b>NOT</b> use this scheme to control <b>non-dimmable</b> lighting.
<b>OSLA</b>	This is an <b>occupancy sensing control</b> scheme can be applied in spaces that require automatic lighting when the ambient light level is lower than the set threshold. Lighting will be inhibited if the ambient light level is higher than the set threshold, regardless of occupancy or vacancy. When the ambient light level is lower than the set threshold, the sensor will automatically control the light at Low Dim level. When sensor detects the presence of an occupant, lighting output will be increased to the High Dim level or continuously regulated within the pre-set range by SmartDIM control. After the delay time elapsed, lighting output will be reduced to Low Dim level or shut off if the ambient light is higher than the set threshold. <b>NOTE:</b> Do <b>NOT</b> use this scheme to control <b>non-dimmable</b> lighting.
<b>OSLATO</b>	This is an <b>occupancy sensing control</b> scheme can be applied in spaces that require maintaining Low Dim lighting for a period of time before shutting off. Lighting will be inhibited if the ambient light level is higher than the set threshold, regardless of occupancy or vacancy. When the ambient light level is lower than the set threshold, and any sensor detects the presence of occupant, lighting output will be increased to High Dim level or continuously regulated to maintain overall lighting level within the pre-set range by SmartDIM control. After the delay time elapsed, lighting output will be reduced to Low Dim level for a period of TIME OFF delay before shut off. <b>NOTE:</b> This scheme requires <b>dimmable</b> lighting to enable dimming control. If lighting is <b>non-dimmable</b> , there will be no dim control and the delay time will be extended with the TIME OFF (TO) delay.
<b>DSVM</b>	This is a <b>daylight sensing control</b> scheme can be applied in spaces that require automatically dimming the lighting output to a low level between a certain time before and after virtual midnight. Lighting will be inhibited if the ambient light level is higher than the set threshold. When the ambient light level is lower than the set threshold, the sensor will turn the light to High Dim level or continuously regulate the output to maintain overall lighting level within the pre-set range by SmartDIM control. Lighting output will be reduced to Low Dim level from a certain time before virtual midnight to a certain time after. <b>NOTE:</b> This scheme requires <b>dimmable</b> lighting to enable dimming control. If lighting is <b>non-dimmable</b> , all lights will remain on whenever ambient light level is lower than the set threshold.
<b>DSC</b>	This is a <b>daylight sensing control</b> scheme can be applied in spaces that require automatic lighting whenever the ambient light is lower than the set threshold. The sensor will automatically turn on the light to High Dim level or continuously regulate the output to maintain overall lighting level within the pre-set range by SmartDIM control when the ambient light level is lower than the set threshold, and automatically turn off the light when the ambient light level is higher than the set threshold. <b>NOTE:</b> This scheme requires <b>dimmable</b> lighting to enable dimming control. If lighting is <b>non-dimmable</b> , all lights will remain on whenever ambient light level is lower than the threshold.
<b>VSC</b>	This is a <b>vacancy sensing control</b> scheme can be applied in spaces that require users to manually turn on the light, and have the sensor turn off the light automatically. The occupant would have to press the OS-NET Button to turn on the lighting group assigned. The sensor will control the lights at High Dim level or continuously regulate the output to maintain overall lighting level within the pre-set range by SmartDIM control. The sensor will control the connected lighting as per OSLATO scheme. <b>NOTE:</b> This scheme requires <b>dimmable</b> lighting to enable dimming control. If lighting is <b>non-dimmable</b> , there will be no dim control and the delay time will be extended with the TIME OFF (TO) delay.
<b>OSB</b>	This is an advanced <b>occupancy sensing control</b> scheme can be applied in open offices to provide background light level before the area of entire lighting group is vacant. Lighting will be inhibited if the ambient light level is higher than the set threshold, regardless of occupancy or vacancy. When the ambient light level is lower than the set threshold and the first occupant is detected by a grouped sensor, the output of sensor connected light will be increased to High Dim level or continuously regulated within the pre-set range by SmartDIM control during occupancy, and the unoccupied areas of entire lighting group will brighten up to Low Dim level as background light. The entire lighting group turns off after the last person leaves and delay time elapsed. <b>NOTE:</b> Do <b>NOT</b> use this scheme to control <b>non-dimmable</b> lighting.
<b>OFF</b>	This is a <b>manual control</b> scheme can be used when you need the light to be off for a certain period of time. Once this scheme is set, all OS-NET controlled lighting will remain off until another scheme is selected.