

# TRANS



## MRD-210S

SmartDALI Occupancy Sensor

### INSTALLATION INSTRUCTIONS

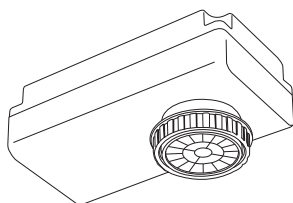

Indoor dry location use only  
Utilisation a L'interieur Uniquement

#### DIMENSIONS

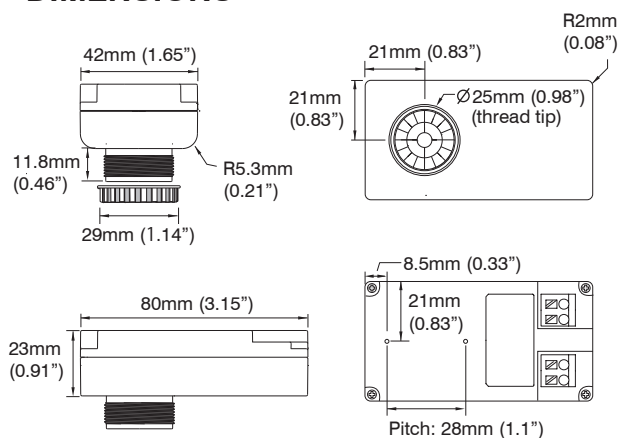

#### WARNING & CAUTION

- Risk of Electric Shock - Disconnect power supply before servicing.
- Use AWG 16-20 solid conductor wires Strip length 8-9 mm / 0.31-0.35 in.
- Cycling the power to the sensors will cause failure over time.

#### INTRODUCTION

The MRD-210S is a low profile, two-way IR remote programmable DALI occupancy sensor featuring bi-level StepDIM or continuous SmartDIM control to lighting with DALI driver or ballast. The sensor can be powered by either AC mains or DALI bus to provide multi-scheme occupancy sensing control with DALI Broadcast commands.

The sensor will command DALI drivers to provide output as programmed when it detects the presence of an occupant or vehicle, and automatically dim to the low level or shut off the light after the area is vacant for a period of time. An exclusive two-way handheld remote programmer allows you to configure the sensor with specific control scheme and settings, or download the existing settings of the installed sensor from the floor.

This compact sensor can be easily integrated with general office luminaires through a 1" hole. A low profile flat lens provides excellent sensing capability for office activities within its coverage.

#### APPLICATION NOTES

1. The sensor is more sensitive to the movements "crossing" the detection zones than "toward" or "away" the sensor unit. To obtain better sensitivity, avoid placing the sensor in line with occupant path, if possible.
2. The closer the movement is to the sensor, the more sensitive the sensor is. The higher the sensor is installed, the larger movement is required to be detected.
3. Ensure to place the sensor at least at 1.5m (5 ft.) away from air supply ducts as rapid air flow may cause false activations.
4. The sensor cannot "see" the movements behind obstacles, such as furniture, shelf, glass or partition. As a general rule, each occupant should be able to clearly view the sensor unit.
5. For open office areas with partition which could block the sensor view to occupant movements, it is best to place the sensors over the intersection of multiple workstations. For large areas of open office or space, place multiple sensors so that there is overlap coverage with each adjacent sensor.

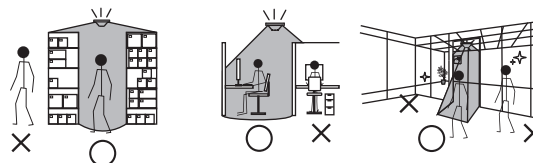

#### DETECTION COVERAGE

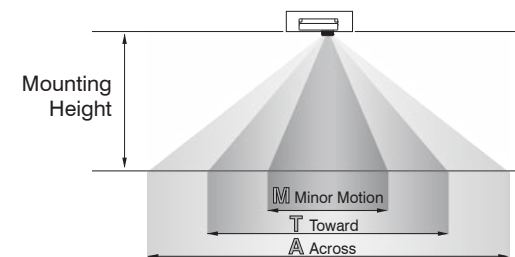

Mounting Height	2.4 m (8 ft)	3.0 m (10 ft)	3.6 m (12 ft)	6.0 m (20 ft)
Coverage Diameter M	1.0 m (3 ft)	2.0 m (7 ft)	3.0 m (10 ft)	--
T	3.0 m (10 ft)	4.0 m (13 ft)	5.0 m (16 ft)	6.0 m (20 ft)
A	5.0 m (16 ft)	6.0 m (20 ft)	7.0 m (23 ft)	9.0 m (30 ft)

**NOTE:** High ambient temperature (above 28°C/82°F) could reduce the coverage of PIR sensor. If ambient temperature at the covered area are expected to be high sometimes, consider adding more sensors or reduce the mounting height, if possible.

#### MOUNTING

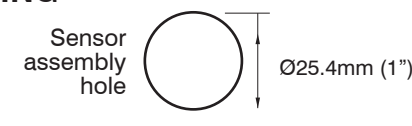

#### Fixture Integration

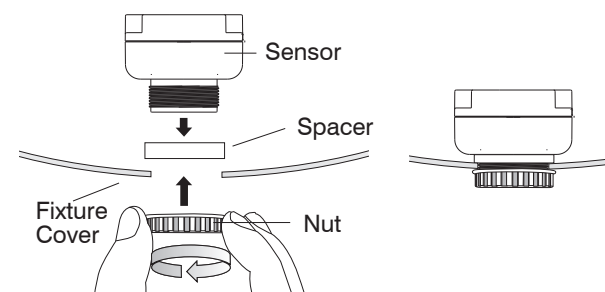

#### Nut-Free Fixture Integration

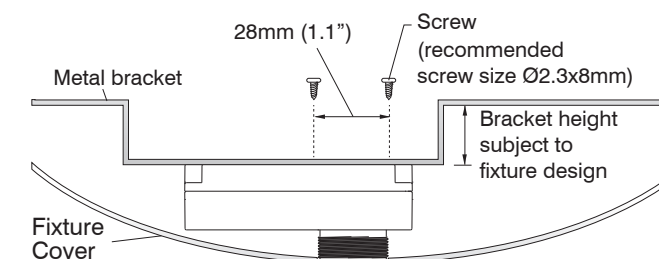

www.irtec.com

P/N: 058-21003-001

Printed in Taiwan

This product may be covered by one or more U.S. patents or patent applications. Please visit [www.irtec.com](http://www.irtec.com) for more information.



## CONTROL MODE

The MRD-210S sensor can be programmed by SRP-280 remote programmer to control the lighting in one of the following modes. For more details of specific control mode, please visit [www.irtec.com](http://www.irtec.com) or contact an IR-TEC team member.

**ON/OFF** : ON-OFF Switching

**OSO** : Occupancy Sensing Only

**OSLA** : Occupancy Sensing at Low Ambient

**OSLATO** : Occupancy Sensing at Low Ambient with Time-Off

**OFF** : Light OFF all the time

Mode	Control
<b>ON/OFF</b>	<ol style="list-style-type: none"> <li>While ambient lux is <b>higher</b> than the level set, light stays <b>OFF</b>.</li> <li>While ambient lux is <b>lower</b> than the level set, and <b>occupancy detected</b>, switch the light to <b>HIGH DIM</b>.</li> <li>Turn <b>OFF</b> the light after occupant leave and delay time elapses.</li> </ol>
<b>OSO</b>	<ol style="list-style-type: none"> <li>Ambient light sensor disabled.</li> <li>Dim the light to <b>LOW DIM</b> at <b>all time</b> under vacancy.</li> <li>Switch the light to <b>HIGH DIM</b> under occupancy.</li> <li>Dim the light to <b>LOW DIM</b> after occupant leave and delay time elapses.</li> </ol>
<b>OSLA</b>	<ol style="list-style-type: none"> <li>While ambient lux is <b>higher</b> than the level set, light stays <b>OFF</b>.</li> <li>While ambient lux is <b>lower</b> than the level set, dim the light to <b>LOW DIM</b> under vacancy.</li> <li>While ambient lux is <b>lower</b> than the level set, and <b>occupancy detected</b>, switch the light to <b>HIGH DIM</b></li> <li>Dim the light to <b>LOW DIM</b> after occupant leave and delay time elapses.</li> </ol>
<b>OSLATO</b>	<ol style="list-style-type: none"> <li>While ambient lux is <b>higher</b> than the level set, light stays <b>OFF</b>.</li> <li>While ambient lux is <b>lower</b> than the level set, and <b>occupancy detected</b>, switch the light to <b>HIGH DIM</b>.</li> <li>Dim the light to <b>LOW DIM</b> after occupant leave and delay time elapses.</li> <li>Turn <b>OFF</b> the lights when <b>TIME OFF</b> delay elapses.</li> <li>When <b>occupancy detected</b> during <b>TIME OFF</b>, switch the light to <b>HIGH DIM</b>.</li> </ol>
<b>OFF</b>	<ol style="list-style-type: none"> <li>All lighting controlled by the sensor will remain <b>OFF</b> until another mode is selected.</li> </ol>

## SENSOR ACKNOWLEDGMENT

Acknowledgement	Sensor LED	Beep	Lighting
Full sensor setting upload completed	-	Long x 1 Short x 2	Flash x 2
Sensor resume to factory default	-	-	Flash x 2
SmartDIM level set completed	-	Short x 2	Flash x 2
Single setting ok	-	Short x 2	-
Occupancy detected	Flash x 1	-	-

## SENSOR SETTINGS

The followings are settings and options available with MRD-210S that can be configured through the operation of SRP-280 remote programmer. For more details of remote sensor setting, please refer to the operation instruction of SRP-280.

Settings	Description	Options	Default
<b>CONTROL</b>	The mode that the sensor will control.	ON/OFF, OSO, OSLA, OSLATO, OFF	OSLATO
<b>AMBIENT LUX</b>	Thresholds of ambient light level for sensor to execute the control.	10/20/40/60/100/200/400 LUX/DISABLED	DISABLED
<b>DELAY</b>	The delay time that sensor is set to turn off or dim the light after the area is vacant.	30 sec./1/3/5/10/15/20/30/60 min.	10 min.
<b>TIME OFF</b>	The delay time that sensor will keep the light at low dim level after the OFF delay time elapsed.	10/30 sec./3/5/10/15/20/30/45/60 min.	10 min.
<b>HIGH DIM</b>	The output level set to control the light during occupancy.	50/55/60/65/70/80/90/100%/SmartDIM	100%
<b>LOW DIM/SmartDIM</b>	The output level set to dim the light when space is vacant for bi-level control. Low dim setting will become SmartDIM bar if SmartDIM control is selected.	0/5/10/15/20/25/30/40%	30%
<b>RAMP UP</b>	The speed of increasing the lighting output to HIGH DIM level.	INSTANT/SOFT/SLOW	INSTANT
<b>FADE DOWN</b>	The speed of decreasing the lighting output to LOW DIM level or off.	INSTANT/SOFT/SLOW	SOFT
<b>DALI POWER</b>	Enable/disable the sensor to provide DALI bus power. NOTE: If total DALI bus power will exceed 250mA after adding the sensor powered by line voltage, please "DISABLED" the DALI POWER.	ENABLED/DISABLED	ENABLED
<b>LED INDICATOR</b>	Enable/disable the LED indicator of sensor.	ENABLED/DISABLED	ENABLED
<b>SENSITIVITY</b>	The sensitivity of occupancy sensor.	HIGH/NORMAL/LOW	HIGH
<b>MIN. DIM</b>	The lowest dim level applicable on the sensor.	12%/15%/DISABLED	DISABLED
<b>DAY O'RIDE</b>	Enable/disable daylight override control. Sensor will shut off the light when ambient lux exceeds the override level set below. Only available if AMBIENT LUX is enabled.	ENABLED/DISABLED	DISABLED
<b>O'RIDE LEVEL</b>	The ambient lux level to enable daylight override. Only available if DAY O'RIDE is enabled.	HIGH/NORMAL/LOW	NORMAL

## WIRING DIAGRAM

### Powered by line voltage

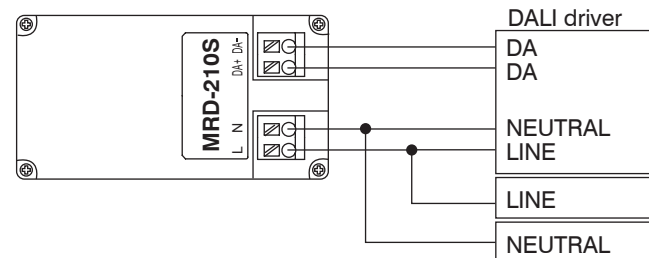

### Powered by DALI bus

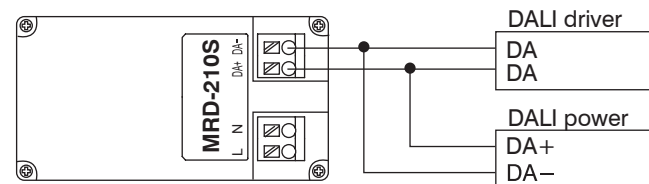

## SPECIFICATIONS

Power supply	230-240VAC or DALI bus power
Power consumption	<0.5W @AC230-240V, <15mA with DALI bus
Infrared sensor	Omni-directional pyroelectric
Photo sensor	Digital ambient light sensor
DALI power output	100 mA max.
Control protocol	DALI Broadcast
Detectable speed	0.3 ~ 3 m/sec. (1~10 ft/sec.)
Mounting height	2.4~6m (8~20 ft)
Detection range	Subject to the mounting height
Op. humidity	Max. 95% RH, non-condensated
Op. temperature	-40°C~70°C(-40°F~158°F)
Dimensions	80x42x34.8mm(3.15"x1.65"x1.37")

[www.irtec.com](http://www.irtec.com)

**IR-TEC**