

PIR + Microwave Motion Detector

DUOGUARD DP-550

GENERAL

Thank you for choosing IR-TEC dual technology motion detector for your security system. The DP-550 is a compact motion detector that combines a passive infrared (PIR) and a microwave (MW) motion sensor. The alarm signal will be transmitted when both sensors detect the motion at the same time. It provides superior reliability in intrusion detection to your alarm system. A unique ceiling/wall mount bracket is provided for easy adjustment of detection coverage.

INSTALLATION HINTS

The DP-550 may be either wall or corner mounted by applying different knockouts. The provided mounting bracket can be applied for ceiling or wall mount. Corner mount is recommended for optimum detection.

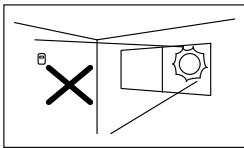

Do not install where the detector is in or facing direct/reflected sunlight, window onto main road to avoid car head light.

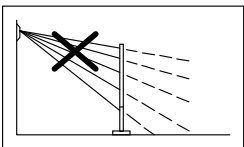

Ensure that there are not any obstructions (plants, screens, furniture etc.) in the field of view which may block the detection.

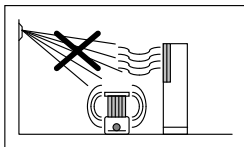

The detector should not face to the ventilation of HVAC or any equipment that may produce strong temperature change.

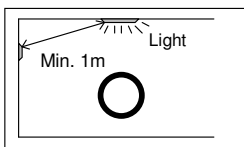

Locate the detector at least 1 meter away from the nearest fluorescent light to avoid interference to MW sensor.

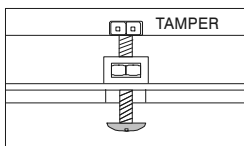

The tamper protection will be activated if the locking screw of front cover and bottom case is loosen. Ensure to fix the screw.

⚡ Avoid running the alarm cable along with AC mains cables !!!

Installation Instructions

DESCRIPTION

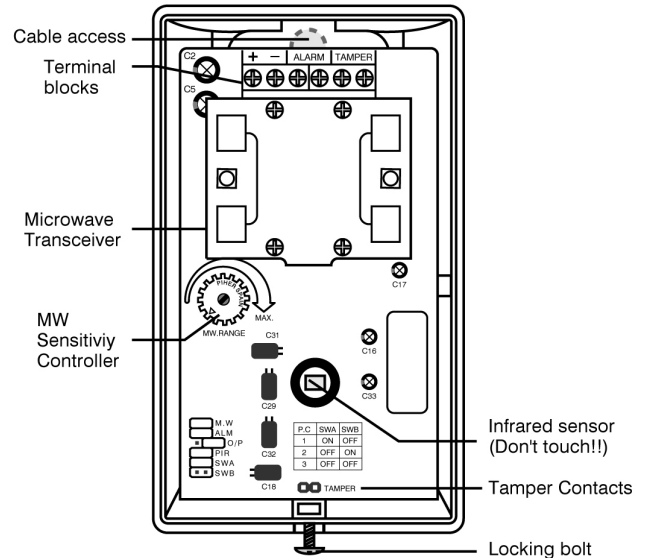

MOUNTING OPTIONS

Ceiling mount

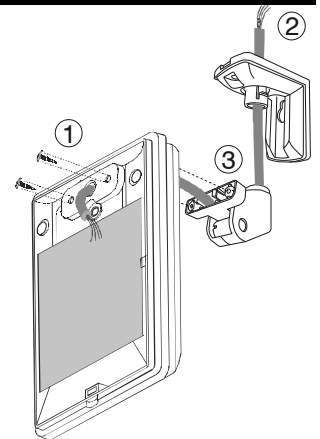
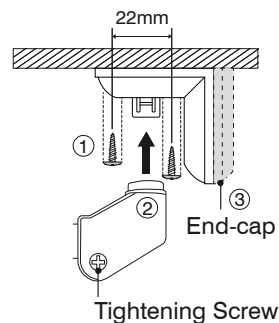

Wall mount

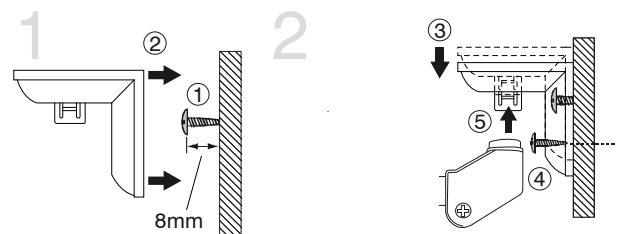

Note: The end-cap can be snap-in to cover the back of bracket.

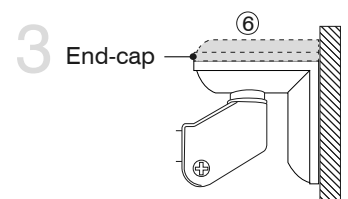

MOUNTING & WIRING

With mounting bracket

1. Mount the base of mounting bracket on the selected position. Lead the cable through the cable access tunnel of mounting bracket.
2. Open the front cover and carefully remove the PCB from the bottom case. Lead the cable into the case and assemble the mounting bracket with it (as shown on previous page).
3. Connect the cable to the corresponding terminals according to the following instructions. Replace the PCB on the bottom case and fix it. Replace the front cover and then walk test can be conducted.

Without mounting bracket

1. Open the front cover and carefully remove the PCB from the bottom case. Select the adequate knockouts and mount the case on the position.
2. Connect the cable to the corresponding terminals according to the following instructions. Replace the PCB on the bottom case and fix it. Replace the front cover and then walk test can be conducted.

Wiring Diagram

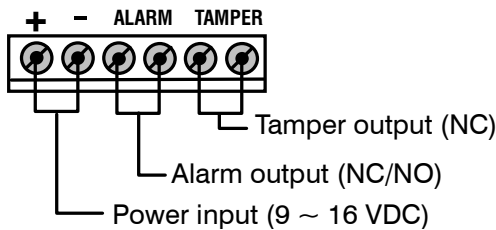

- ◆ **TAMPER:** Connect to the tamper protection loop.
- ◆ **ALARM:** Alarm output (NC/NO)
- ◆ - : Ground of DC power input.
- ◆ +: Positive of DC power input.

WALK TEST

It is necessary to carry out a thorough walk test of the detector to ensure that the correct coverage is being achieved. Also to ensure that both PIR & microwave are sensors working to the same detection area.

1. Apply the DC power supply and give about 60 seconds for sensor to warm up. After the warm up time expires, walk across the detection zones at normal speed. The red LED will lit when it detects the motion.
2. If microwave sensor is over sensitive (green LED remains on), adjust of the thumb wheel of MW sensitivity trimmer in counterclockwise until ideal detection range is obtained.

JUMPER SWITCH SETTING

A 6x2-pin jumper switch is available for various settings of the detector. Please refer the following instructions for setting options.

Code	Description	Placed (ON)	Removed (OFF)
MW	MW sensor detection	Enable MW LED indication	Disable MW LED indication
ALM	Alarm relay output	Enable alarm LED indication	Disable alarm LED indication
O/P	Output format	N.O. output	N.C. output
PIR	PIR sensor detection	Enable PIR LED indication	Disable PIR LED indication

Pulse count selection

Code	Pulse count 1	Pulse count 2	Pulse count 3
SWA	ON	OFF	OFF
SWB	OFF	ON	OFF

DETECTION PATTERN

Model: **DP-550**

110°, 15 x 15m at 25°C

Top View

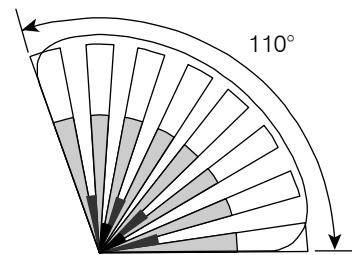

Side View

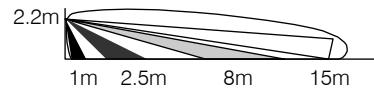

SPECIFICATIONS

- Power supply9 ~ 16 VDC, 12 VDC typical
- Current drain30 mA @ 12 VDC
- Infrared sensorDual element, pyroelectric
- Microwave sensorDRO, patch antenna
- Alarm period1.5 ~ 2.5 seconds
- Alarm outputNC/NO, 30 VDC, 0.2A max.
- Tamper protectionNC, screw release activated
- Mounting height1.8 ~3.6 m
- Mounting bracketMB-100 included(DP-550-B)
- Detectable speed0.1~3.0 m/sec.
- RFI immunityAv. 20 V/m (10~1,000 MHz)
- Temperature-20°C~50°C (-4°F ~ 122°F)
- Humidity95% RH max.
- Dimensions112 x 66 x 45 mm