

TRANS



MRD-200SP EU

SmartDALI Occupancy Sensor

INSTALLATION INSTRUCTIONS

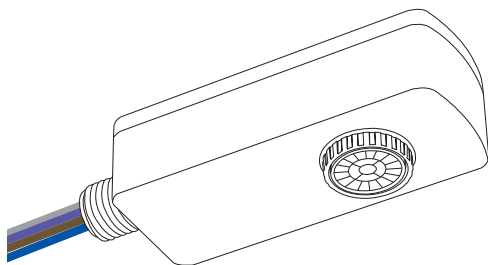

DIMENSIONS

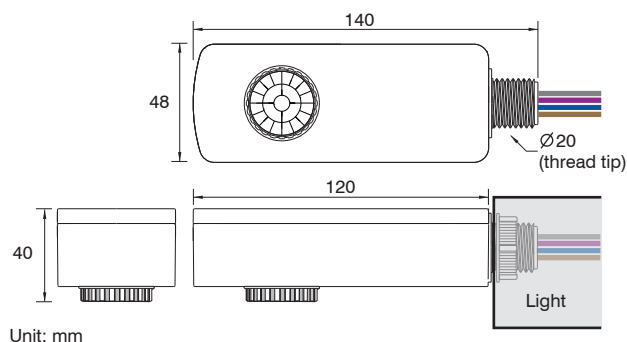

WARNING & CAUTION

- Risk of Electric Shock - Disconnect power supply before servicing.
- Cycling the power to the sensors will cause failure over time.

INTRODUCTION

The MRD-200SP is a low profile, two-way IR remote programmable DALI occupancy sensor featuring bi-level StepDIM or continuous SmartDIM control to lighting with DALI driver or ballast. The sensor can be powered by either AC mains or DALI bus to provide multi-scheme occupancy sensing control with DALI Broadcast commands.

The sensor will command DALI drivers to provide output as programmed when it detects the presence of an occupant or vehicle, and automatically dim to the low level or shut off the light after the area is vacant for a period of time. An exclusive two-way handheld remote programmer (SRP-280) allows you to configure the sensor with specific control scheme and settings, or download the existing settings of the installed sensor from the floor.

This IP-65 batten mount sensor can be externally assembled with an OEM luminaire through a 1/2" hole. A low profile flat lens provides excellent low-bay occupancy sensing capability within its coverage of 2X mounting height.

APPLICATION NOTES

1. The sensor is more sensitive to the movements "crossing" the detection zones than "toward" or "away" the sensor unit. To obtain better sensitivity, avoid placing the sensor in line with occupant path, if possible.
2. The closer the movement is to the sensor, the more sensitive the sensor is. The higher the sensor is installed, the larger movement is required to be detected.
3. Ensure to place the sensor at least at 1.5m (5 ft.) away from air supply ducts as rapid air flow may cause false activations.
4. The sensor cannot "see" the movements behind obstacles, such as furniture, shelf, glass or partition. As a general rule, each occupant should be able to clearly view the sensor unit.
5. For open office areas with partition which could block the sensor view to occupant movements, it is best to place the sensors over the intersection of multiple workstations. For large areas of open office or space, place multiple sensors so that there is overlap coverage with each adjacent sensor.

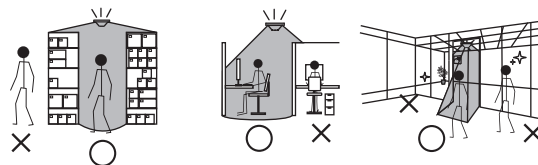

DETECTION COVERAGE

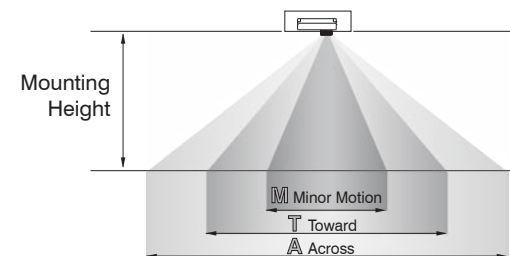

Mounting Height		2.4 m (8 ft)	3.0 m (10 ft)	3.6 m (12 ft)	6.0 m (20 ft)
Coverage Diameter	M	1.0 m (3 ft)	2.0 m (7 ft)	3.0 m (10 ft)	--
	T	3.0 m (10 ft)	4.0 m (13 ft)	5.0 m (16 ft)	6.0 m (20 ft)
	A	5.0 m (16 ft)	6.0 m (20 ft)	7.0 m (23 ft)	9.0 m (30 ft)

MOUNTING

- ① Assemble the sensor with luminaire via the knockout hole

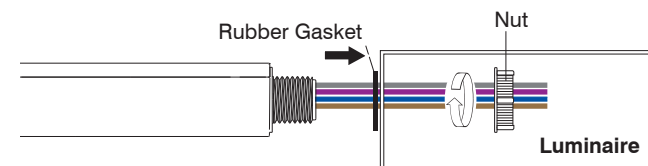

- ② Tighten the screw nut

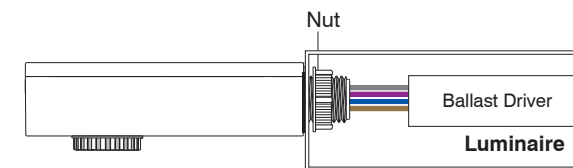

CONTROL MODE

The MRD-200SP sensor can be programmed by SRP-280 remote programmer to control the lighting in one of the following modes. For more details of specific control mode, please visit www.irtec.com or contact an IR-TEC team member.

ON/OFF : ON-OFF Switching

OSO : Occupancy Sensing Only

OSLA : Occupancy Sensing at Low Ambient

OSLATO : Occupancy Sensing at Low Ambient with Time-Off

OFF : Light OFF all the time

Mode	Control
ON/OFF	<ol style="list-style-type: none"> While ambient lux is higher than the level set, light stays OFF. While ambient lux is lower than the level set, and occupancy detected, switch the light to HIGH DIM. Turn OFF the light after occupant leave and delay time elapses.
OSO	<ol style="list-style-type: none"> Ambient light sensor disabled. Dim the light to LOW DIM at all time under vacancy. Switch the light to HIGH DIM under occupancy. Dim the light to LOW DIM after occupant leave and delay time elapses.
OSLA	<ol style="list-style-type: none"> While ambient lux is higher than the level set, light stays OFF. While ambient lux is lower than the level set, dim the light to LOW DIM under vacancy. While ambient lux is lower than the level set, and occupancy detected, switch the light to HIGH DIM Dim the light to LOW DIM after occupant leave and delay time elapses.
OSLATO	<ol style="list-style-type: none"> While ambient lux is higher than the level set, light stays OFF. While ambient lux is lower than the level set, and occupancy detected, switch the light to HIGH DIM. Dim the light to LOW DIM after occupant leave and delay time elapses. Turn OFF the lights when TIME OFF delay elapses. When occupancy detected during TIME OFF, switch the light to HIGH DIM.
OFF	<ol style="list-style-type: none"> All lighting controlled by the sensor will remain OFF until another mode is selected.

SENSOR ACKNOWLEDGMENT

Acknowledgement	Sensor LED	Beep	Lighting
Full sensor setting upload completed	-	Long x 1 Short x 2	Flash x 2
Sensor resume to factory default	-	-	Flash x 2
SmartDIM level set completed	-	Short x 2	Flash x 2
Single setting ok	-	Short x 2	-
Occupancy detected	Flash x 1	-	-

SENSOR SETTINGS

The followings are settings and options available with MRD-200SP that can be configured through the operation of SRP-280 remote programmer. For more details of remote sensor setting, please refer to the operation instruction of SRP-280.

Settings	Description	Options	Default
CONTROL	The mode that the sensor will control.	ON/OFF, OSO, OSLA, OSLATO, OFF	OSLATO
AMBIENT LUX	Thresholds of ambient light level for sensor to execute the control.	10/20/40/60/100/200/400 LUX/DISABLED	DISABLED
DELAY	The delay time that sensor is set to turn off or dim the light after the area is vacant.	30 sec./1/3/5/10/15/20/30/60 min.	10 min.
TIME OFF	The delay time that sensor will keep the light at low dim level after the OFF delay time elapsed.	10/30 sec./3/5/10/15/20/30/45/60 min.	10 min.
HIGH DIM	The output level set to control the light during occupancy.	50/55/60/65/70/80/90/100%/SmartDIM	100%
LOW DIM/SmartDIM	The output level set to dim the light when space is vacant for bi-level control. Low dim setting will become SmartDIM bar if SmartDIM control is selected.	0/5/10/15/20/25/30/40%	30%
RAMP UP	The speed of increasing the lighting output to HIGH DIM level.	INSTANT/SOFT/SLOW	INSTANT
FADE DOWN	The speed of decreasing the lighting output to LOW DIM level or off.	INSTANT/SOFT/SLOW	SOFT
DALI POWER	Enable/disable the sensor to provide DALI bus power. NOTE: If total DALI bus power will exceed 250mA after adding the sensor powered by line voltage, please "DISABLED" the DALI POWER.	ENABLED/DISABLED	ENABLED
SENSITIVITY	The sensitivity of occupancy sensor.	HIGH/NORMAL/LOW	HIGH
LED INDICATOR	Enable/disable the LED indicator of sensor.	ENABLED/DISABLED	ENABLED

WIRING DIAGRAM

Powered by line voltage

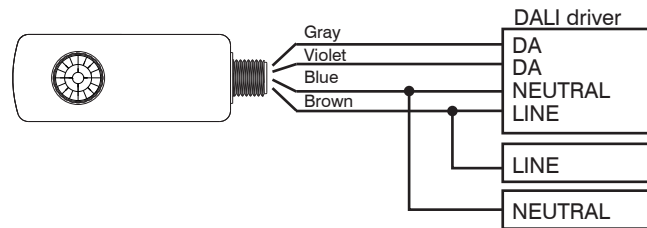

Powered by DALI bus

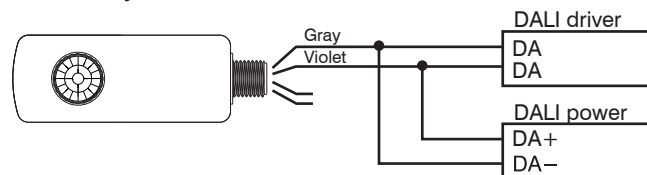

SPECIFICATIONS

Power supply	230-240VAC or DALI bus power
Power consumption	<0.5W @230VAC, <15mA with DALI bus
Infrared sensor	Omni-directional pyroelectric
Photo sensor	Digital ambient light sensor
DALI power output	100 mA max.
Control protocol	DALI Broadcast
Detectable speed	0.3 ~ 3 m/sec. (1~10 ft/sec.)
Mounting height	2.4~6m (8~20 ft)
Detection range	Subject to the mounting height
Op. humidity	Max. 95% RH, non-condensated
Op. temperature	-40°C~70°C(-40°F~158°F)
Dimensions	140x48x40mm (5.51"x1.89"x1.50")