

OS-361DT

Low Voltage Dual-Tech Occupancy Sensor

INSTALLATION INSTRUCTIONS

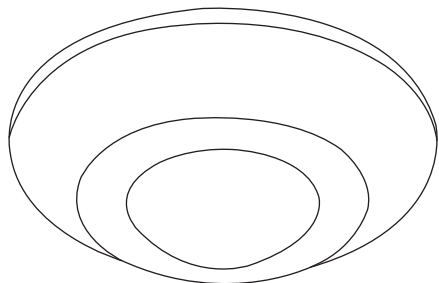

Indoor dry location use only
Utilisation a L'interieur Uniquement

⚠ WARNING & CAUTION

- Turn power OFF at circuit breaker before connecting Power Pack or Sensor.
- Wire all Class 2 circuits using types CL3, CL3P, CL3R, or equivalent conductors.
Install the sensor at least 1ft. away from any occupant.

⚠ AVERTISSEMENT & PRUDENCE

- Coupez l'alimentation au disjoncteur avant d'installer Power Pack ou capteurs.
- Câble toute classes 2 circuits CL3, CL39, CL3R ou conducteur équivalent.

Federal Communication Commission Interference Statement

This device complies with Part 15 of the FCC Rules. Operation is subject to the following two conditions: (1) This device may not cause harmful interference, and (2) this device must accept any interference received, including interference that may cause undesired operation.

This equipment has been tested and found to comply with the limits for a Class B digital device, pursuant to Part 15 of the FCC Rules. These limits are designed to provide reasonable protection against harmful interference in a residential installation. This equipment generates, uses and can radiate radio frequency energy and, if not installed and used in accordance with the instructions, may cause harmful interference to radio communications. However, there is no guarantee that interference will not occur in a particular installation. If this equipment does cause harmful interference to radio or television reception, which can be determined by turning the equipment off and on, the user is encouraged to try to correct the interference by one of the following measures:

OVERVIEW

The OS-361DT is a ceiling mount low voltage dual technology occupancy sensor designed for area lighting, or HVAC control, for energy efficient building management. The sensor combines a Passive Infrared (PIR) sensor, a High Frequency Doppler (HFD) sensor and advanced signal processing firmware to perform superior occupancy sensing capability.

An omni-directional quad element PIR sensor, a state-of-the-art HFD sensor and advanced signal processing firmware are employed to provide superior occupancy sensing capability. The sensor will activate the relay output and delay timer when both PIR and HFD sensors detect the presence of occupant. The delay timer will be reset if either PIR or HFD sensor detects motion before the delay time has elapsed.

The OS-361DT is ideal for areas where motion may not be easily detectable by a single technology occupancy sensor. The sensor is operated by 24VDC low voltage power supplied from an IR-TEC power pack, or building management system. The sensor provides a form A relay dry contact for control of lighting and/or HVAC systems.

SPECIFICATIONS

| | |
|-------------------|---|
| Power supply | 24±2 VDC |
| Current drain | 20/33 mA @ 24 VDC, vacant/occupied |
| Signal output | Form A, 30VDC, 0.2A max. |
| Infrared sensor | Quad element pyroelectric infrared sensor |
| HFD sensor | X-band DRO type with patch antenna |
| HFD sensitivity | 60/80/100/120% selectable |
| Detectable speed | 0.33 ~ 10 ft/sec. (0.1 ~ 3 m/sec.) |
| Mounting height | 8 ~ 12 ft. (2.4 ~ 3.6 m) |
| Detection range | 2.5 X mounting height in diameter |
| OFF delay setting | 0/1'3'/5'/10'/15'/20'/30' selectable |
| Op. humidity | Max. 95% RH |
| Op. temperature | -4°F ~ 122°F (-20°C ~ 50°C) |
| Dimensions | 4.4" dia. x 1.7" depth (110 mm x 44mm) |

FCC ID: NRIOS-361DT

- Reorient or relocate the receiving antenna.
- Increase the separation between the equipment and receiver.
- Connect the equipment into an outlet on a circuit different from that to which the receiver is connected.
- Consult the dealer or an experienced radio/TV technician for help.

FCC Caution: Any changes or modifications not expressly approved by the party responsible for compliance could void the user's authority to operate this equipment.

This transmitter must not be co-located or operating in conjunction with any other antenna or transmitter.

Radiation Exposure Statement:

This equipment complies with FCC radiation exposure limits set forth for an uncontrolled environment. This equipment should be installed and operated with minimum distance 20cm between the radiator & your body.

APPLICATION NOTES

1. PIR sensor is more sensitive to the movements "crossing" the detection zones than "toward" or "away" the sensor unit. Avoid placing the sensor in line with the path of occupant, if possible.
2. PIR sensor cannot "see" the movements behind obstacles, such as furniture, shelf, glass or partitions. As a general rule, ensure to place the sensor at where the occupant could have clear view of the sensor.
3. HFD sensor may penetrate through certain types of non-metallic partition material (glass, plaster, plywood... etc) and detects the movements outside of partition. Adjusting the HFD sensitivity may be necessary to achieve optimal detection.
4. Place the sensor at least at 5 ft. (1.5m) away from air supply duct and fluorescent lighting to avoid false activating.
5. For open office areas with partition which could block the sensor view to occupant movements, it is recommended to place the sensors over the intersection of multiple workstations. For large areas of open office or space, place multiple sensors so that there is overlap coverage with each adjacent sensor.
6. The OS-361DT can be either surface mounted or recess mounted in a hole with 3.4" diameter on the ceiling.

DETECTION PATTERN

Top View

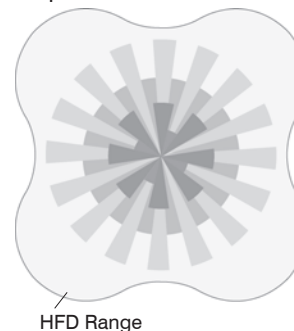

| | | | |
|-----------------|-----|-----|-----|
| Mounting Height | 8' | 10' | 12' |
| Coverage (dia.) | 20' | 24' | 30' |

Side View

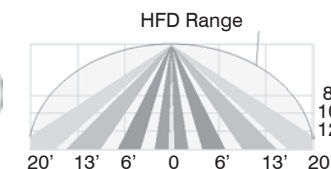

DIMENSIONS

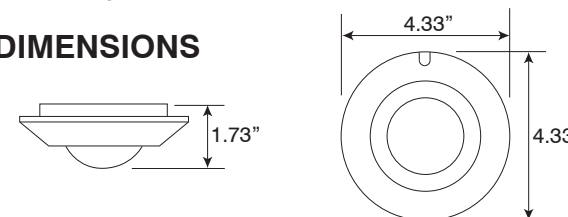

SENSOR OPERATION

The OS-361DT is an occupancy sensor which combines two different sensing technologies, PIR and HFD, in one housing for ceiling mount installation. The sensor is operated by 24 VDC low voltage power. Whenever the sensor detects the presence of occupant, its dry contact relay output will be engaged for the delay time programmed. The delay timer will be reset if any motion is detected by either PIR or HFD sensor before delay time elapses.

8 different delay times and 4 different HFD sensitivity levels can be programmed via specific DIP switch combinations. 2 LED's are available to indicate the operation of PIR and HFD sensors respectively. The sensor operation LED can be disabled by specific DIP switch, if necessary.

WIRING DIAGRAM

Various control modes may be achieved by different wiring connections. The following diagrams are typical control for reference. For the availability of more complex control, please contact an IR-TEC team member directly.

A. Auto-ON/Auto-OFF

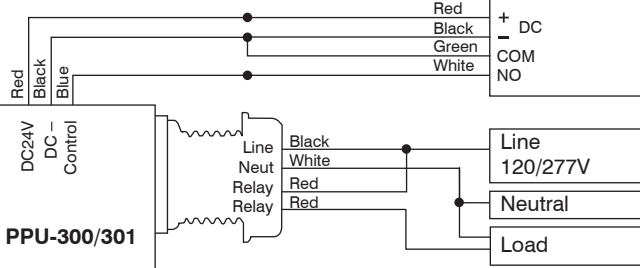

B. Manual-ON/Auto-OFF with PPU-300

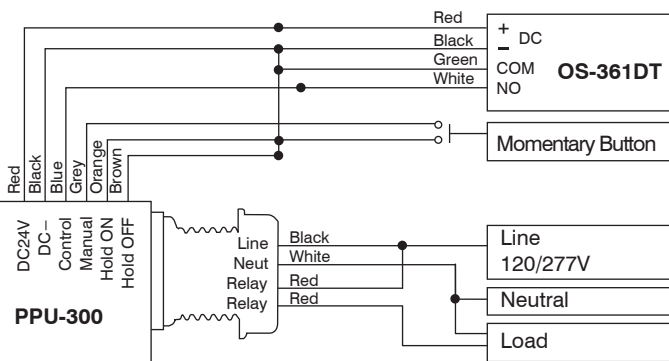

NOTE: Each IR-TEC PPU-300/301 power pack can supply power for up to 3 OS-361DT sensors. When more sensors are connected, multiple power packs may be required.

MOUNTING THE SENSOR

1. Loosen the locking screw to the position where the front cover can be removed. Leave the screw attached with
2. Connect the wire leads with IR-TEC power pack or BMS as per wiring diagram of the desired control.
3. Mount the sensor base with screws provided. For surface mount, use two knockout holes underneath both sides of the PCBA. For recess mount, use two holes on the flange of sensor base.
4. Replace the front cover and tighten the locking screw.

Note: The supplied rubber pad can be used to cover the locking screw for aesthetic purpose. The respective LED will light on whenever PIR (blue) or HFD (green) sensor detects the motion.

RANGE TEST

It is recommended to conduct a walk test to verify optimum coverage after sensor installed. To test the sensor range, restore the front cover, apply the low voltage power and wait approximately 90 seconds for sensor to warm up. The LED will blink during warm-up period. Walk into the projected area in the path of occupant show up and observe if the sensor can detect the presence. The LED will be lit whenever sensor detects the motion. If the space has multiple entrances, repeat the test in all available paths.

Note: Stay out of sensor coverage during warm-up to avoid extending the period.

SENSOR INTERNAL

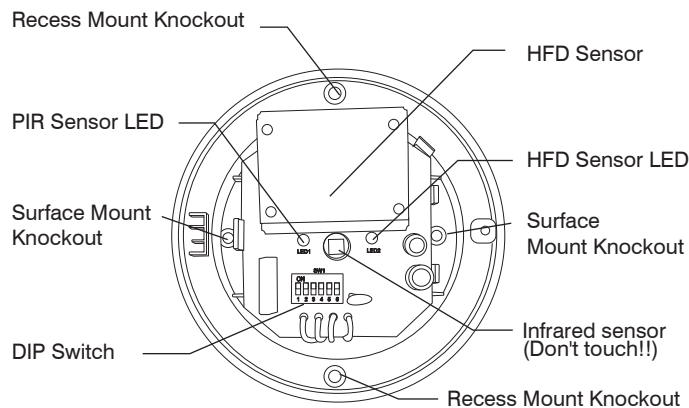

SENSOR SETTINGS

A 6-pole DIP switch is available for various sensor settings via combinations of ON and OFF positions of specific switch.

HFD SENSITIVITY – SW #1 & #2

HFD sensor could possibly detect the movements outside of certain type of dry wall or partition. If happened, sensitivity can be adjusted by changing the ON-OFF combinations of DIP switch #1 and #2 as the following table shows.

| 60% | 80% | 100% * | 120% |
|-----|-----|--------|------|
| | | | |

*Factory Set

LED ON/OFF – SW #3

2 LED's are available to indicate the status of PIR and HFD sensor operation. The LED indication can be disabled by setting the SW #3 to OFF position.

OFF DELAY – SW #4, #5, & #6

Total 8 different delay times can be selected via the combinations of SW #4, #5 and #6 as the following table shows.

| 0 sec. | 1 min. | 3 min. | 5 min. |
|----------|---------|---------|---------|
| | | | |
| 10 min.* | 15 min. | 20 min. | 30 min. |
| | | | |

* Factory Set

WARRANTY

IR-TEC International Ltd. warranties this product to be free of defects in materials or workmanship for a period of five years from date of shipment. There are no obligations or liabilities on the part of IR-TEC International Ltd. for consequential damages arising out or in connection with the use or performance of this product or other indirect damages with respect to loss of property, revenue, or profit, or cost of removal, installation or reinstallation.

